

KAISAI

R32



**WE
CARE
ABOUT
AIR**

ENGINEERING DATA
MONO TYPE HEAT PUMP

CONTENTS

Part 1 General Information.....	3
Part 2 Engineering Data.....	17
Part 3 Installation and Field Settings.....	55

Part 1

General Information

1 Mono System	4
2 Unit Capacities	6
3 Nomenclature	6
4 System Design and Unit Selection	7
5 Typical Applications	9

Mono

1 Mono System

1.1 System Schematic

Figure 1-1.1: System schematic

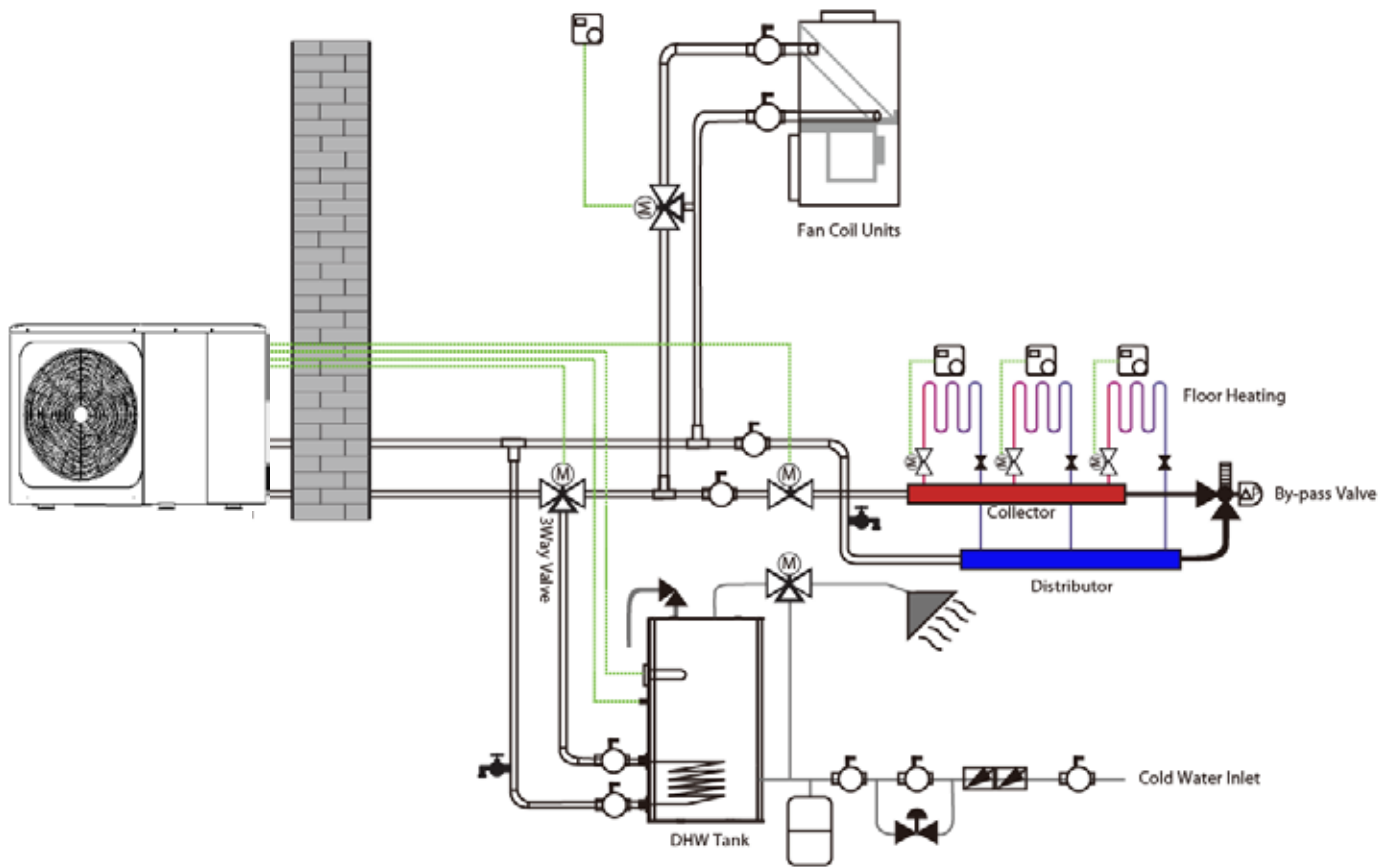

Mono is an integrated air to water heat pump system which is one-stop solution for space heating, space cooling and domestic hot water, The outdoor heat pump system extracts heat from the outdoor air and transfers this heat through refrigerant piping to the plate heat exchanger in the hydronic system. The heated water in the hydronic system circulates to low temperature heat emitters (floor heating loops or low temperature radiators) to provide space heating, and to the domestic hot water tank to provide domestic hot water. The 4-way valve in the outdoor unit can reverse the refrigerant cycle so that the hydronic system can provide chilled water for cooling using fan coil units.

The heating capacity of heat pumps decreases with ambient temperature dropping. Mono can be equipped with a backup electric heater to provide additional heating capacity for use during extremely cold weather when the heat pump capacity is insufficient. The backup electric heater also serves as a backup in case of heat pump malfunction and for anti-freeze protection of the outside water piping in winter.

1.2 System Configurations

Mono can be configured to run with the electric heater either enabled or disabled and can also be used in conjunction with an auxiliary heat source such as a boiler.

The chosen configuration affects the size of heat pump that is required. Three typical configurations are described below. Refer to Figure 1-1.2.

Configuration 1: Heat pump only

- The heat pump covers the required capacity and no extra heating capacity is necessary.
- Requires selection of larger capacity heat pump and implies higher initial investment.
- Ideal for new construction in projects where energy efficiency is paramount.

Configuration 2: Heat pump and backup electric heater

- Heat pump covers the required capacity until the ambient temperature drops below the point at which the heat pump is able to provide sufficient capacity. When the ambient temperature is below this equilibrium point (as shown in Figure 1-1.2), the backup electric heater supplies the required additional heating capacity.
- Best balance between initial investment and running costs, results in lowest lifecycle cost.
- Ideal for new construction.

Configuration 3: Heat pump with auxiliary heat source

- Heat pump covers the required capacity until the ambient temperature drops below the point at which the heat pump is able to provide sufficient capacity. When the ambient temperature is below this equilibrium point (as shown in Figure 1-1.2), depending on the system settings, either the auxiliary heat source supplies the required additional heating capacity or the heat pump does not run and the auxiliary heat source covers the required capacity.
- Enables selection of lower capacity heat pump.
- Ideal for refurbishments and upgrades.

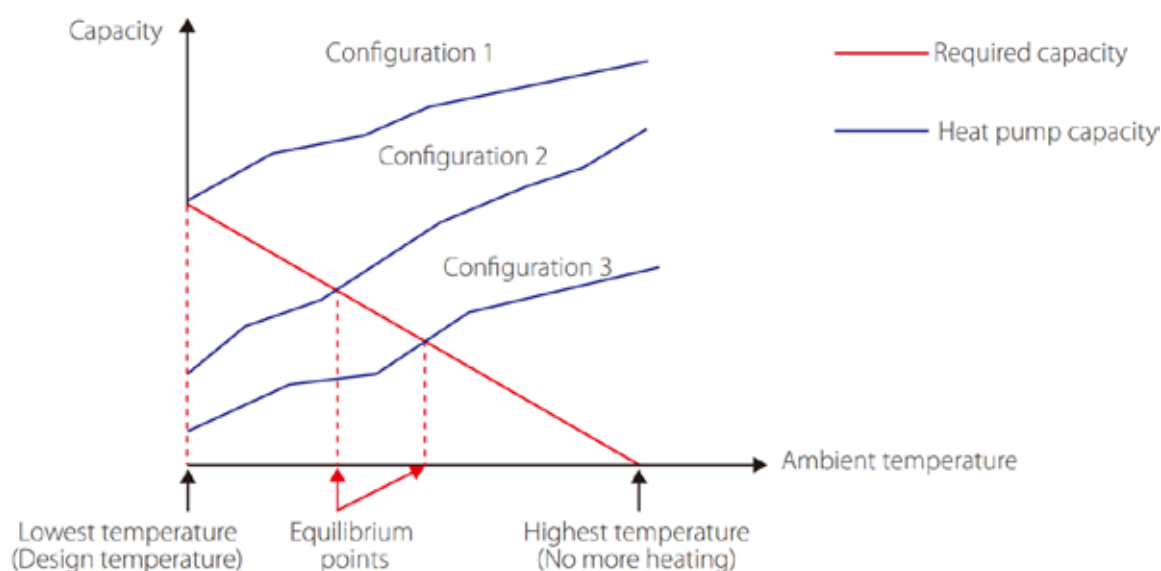

Figure 1-1.2: System configurations



Mono

2 Unit Capacities

Table 1-2.1: Mono unit capacity range and unit appearances

Capacity	6kW	8kW	10kW	12kW	14kW	16kW
Model	KHC-06RY1-B	KHC-08RY3-B	KHC-10RY3-B	KHC-12RY3-B	KHC-14RY3-B	KHC-16RY3-B
Appearance						

3 Nomenclature

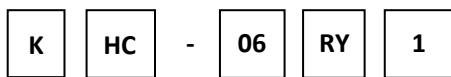

Power supply
 1 - 1 phase, 220-240V, 50Hz
 3 - 3 phase, 380-415V, 50Hz

RY - Refrigerant R32 Arctic

06 - 6 kW
 08 - 8 kW
 10 - 10 kW
 12 - 12 kW
 14 - 14 kW
 16 - 16 kW

HC - Monobloc

K - Kaisai

4 System Design and Unit Selection

4.1 Selection Procedure

Step 1: Total heat load calculation

Calculate conditioned surface area
Select the heat emitters (type, quantity, water temperature and heat load)

Step 2: System configuration

Decide whether to include AHS and set AHS's switching temperature
Decide whether backup electric heater is enabled or disabled

Step 3: Selection of outdoor units

Determine required total heat load on outdoor units
Set capacity safety factor
Select power supply

Provisionally select Mono unit capacity based on nominal capacity

Correct capacity of the outdoor units for the following items:
Outdoor air temperature / Outdoor humidity / Water outlet temperature¹ /
Altitude / Anti-freeze fluid

Is corrected Mono unit capacity \geq Required total heat load on outdoor units²

Yes

No

Mono system selection
is complete

Select a larger model or enable
backup electric heater operation

Notes:

1. If the required water temperatures of the heat emitters are not all the same, the Mono's outlet water temperature setting should be set at the highest of the heat emitter required water temperatures. If the water outlet design temperature falls between two temperatures listed in the outdoor unit's capacity table, calculate the corrected capacity by interpolation.
2. If the outdoor unit selection is to be based on total heating load and total cooling load, select Mono units which satisfy not only the total heating load requirements but also the total cooling load requirements.

Mono

4.2 Leaving Water Temperature (LWT) Selection

The recommended design LWT ranges for different types of heat emitter are:

- For floor heating: 30 to 35°C
- For fan coil units: 30 to 45°C
- For low temperature radiators: 40 to 50°C

4.3 Optimizing System Design

To get the most comfort with the lowest energy consumption with Mono heat pump, it is important to take account of the following considerations:

- Choose heat emitters that allow the heat pump system to operate at as low a hot water temperature as possible whilst still providing sufficient heating.
- Make sure the correct weather dependency curve is selected to match the installation environment (building structure, climate) as well as ender user's demands.
- Connecting room thermostats (field supplied) to the hydronic system helps prevent excessive space heating by stopping the outdoor unit and circulator pump when the room temperature is above the thermostat set point.

4.4 Tank back up heater notice

Heat pump will stop when T5(tank temperature) has reached the minimum of both T5S(tank setting temperature) and T5stop (highest tank temperature which can be reached under certain ambient temperature with heat pump only) and lasted for 5s. The value of T5stop is shown as below.

If T5S is higher than T5stop, then T5S can not be reached with heat pump only. In this case, tank back up heater is needed in order to reach T5S.

T5stop value:

Ambient temperature(°C)	< -20	-20~15	-15~-10	-10~-5	-5~0	0~5	5~10
T5stop(°C)	35	40	45	48	52	55	56

Ambient temperature(°C)	10~15	15~20	20~25	25~30	35~40	40~65	40~65
T5stop(°C)	57	56	55	52	50	48	45

5 Typical Applications

5.1 Application 1

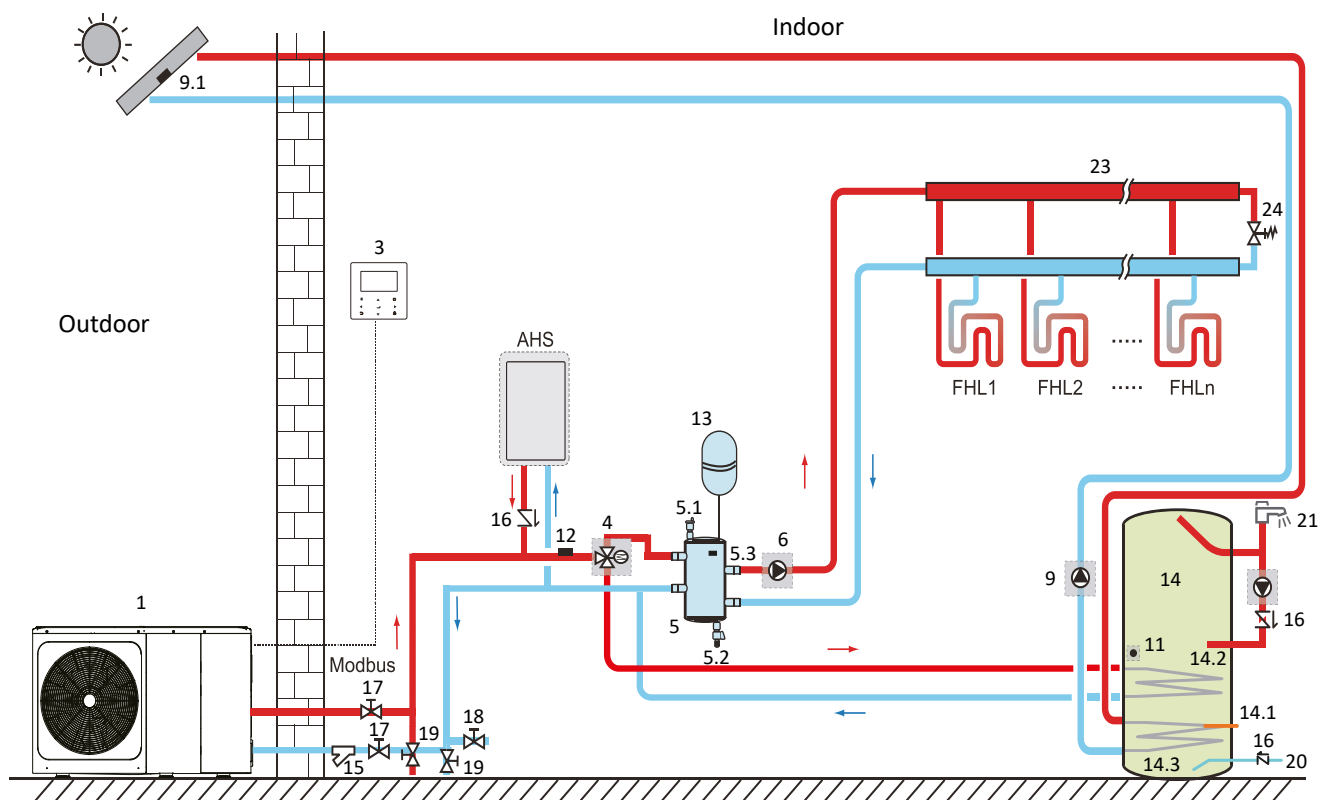

Figure 1-5.1: Application 1

Legend			
1	Outdoor unit	14	Domestic hot water tank (Field supply)
3	User interface	14.1	TBH: Domestic hot water tank booster heater (Field supply)
4	SV1:3-way valve (Field supply)	14.2	Coil 1, heat exchanger for heat pump
5	Balance tank (Field supply)	14.3	Coil 2, heat exchanger for Solar energy
5.1	Automatic bleed valve	15	Filter (Accessory)
5.2	Drainage valve	16	Check valve (Field supply)
5.3	Tbt1: Balance tank upper temperature sensor (Optional)	17	Shut-off valve (Field supply)
6	P_o: Zone A circulation pump (Field supply)	18	Filling valve (Field supply)
9	P_s: Solar pump (Field supply)	19	Drainage valve (Field supply)
9.1	Tsolar: Solar temperature sensor (Optional)	20	Tap water inlet pipe (Field supply)
9.2	Solar panel (Field supply)	21	Hot water tap (Field supply)
10	P_d: DHW pipe pump (Field supply)	23	Collector/distributor (Field supply)
11	T5: Domestic water tank temperature sensor (Accessory)	24	Bypass valve (Field supply)
12	T1: Water flow temperature sensor (Optional)	FHL1...n	Floor heating loop (Field supply)
13	Expansion vessel (Field supply)	AHS	Auxiliary heat source (Field supply)

Notes:

1. The example is just for application illustration; please confirm the exact installation method according to the installation manual.

Mono

5.1.1 Space heating

The ON/OFF signal and operation mode and temperature setting are set on the user interface. P_o (6) keeps running as long as the unit is ON for space heating, SV1(4) keeps OFF.

5.1.2 Domestic water heating

The ON/OFF signal and target tank water temperature (T5S) are set on the user interface. P_o (6) stops running as long as the unit is ON for domestic water heating, SV1(4) keeps ON.

5.1.3 AHS (auxiliary heat source) control

The AHS function is set on the indoor unit

1) When the AHS is set to be valid only for heating mode, AHS can be turned on in the following ways:

- a. Turn on the AHS via BACKHEATER function on the user interface;
- b. AHS will be turned on automatically if initial water temperature is too low or target water temperature is too high at low ambient temperature.

P_o (6) keeps running as long as the AHS is ON, SV1(4) keeps OFF.

2) When the AHS is set to be valid for heating mode and DHW mode. In heating mode, AHS control is same as part 1); In DHW mode, AHS will be turned on automatically when the initial domestic water temperature T5 is too low or the target domestic water temperature is too high at low ambient temperature. P_o (6) stops running, SV1(4) keeps ON.

3) When the AHS is set to be valid, M1M2 can be set to be valid on the user interface. In heating mode, AHS will be turned on if MIM2 dry contact closes. This function is invalid in DHW mode.

5.1.4 TBH (tank booster heater) control

The TBH function is set on the user interface.

1) When the TBH is set to be valid, TBH can be turned on via TANKHEATER function on the user interface; In DHW mode, TBH will be turned on automatically when the initial domestic water temperature T5 is too low or the target domestic water temperature is too high at low ambient temperature.

2) When the TBH is set to be valid, M1M2 can be set to be valid on the user interface. TBH will be turned on if MIM2 dry contact closes.

5.1.5 Solar energy control

Hydraulic module recognizes solar energy signal by judging Tsolar or receiving SL1SL2 signal from user interface. The recognition method can be set via SOLAR INPUT on the user interface. Please refer to 8.8.5 "For solar energy input signal" for wiring.

1) When Tsolar is set to be valid, Solar energy turns ON when Tsolar is high enough, P_s(9) starts running; Solar energy turns OFF when Tsolar is low, P_s (9) stops running.

2) When SL1SL2 control is set to be valid, Solar energy turns ON after receiving Solar kit signal from user interface, P_s (9) starts running; Without solar kit signal. Solar energy turns OFF, P_s (9) stops running. The room thermostats are not connected to the Mono unit but to a motorized valve. Each room's temperature is regulated by the motorized valve on its water circuit. Domestic hot water is supplied from the domestic hot water tank connected to the Mono unit. A bypass valve is required.

5.2 Application 2

ROOM THERMOSTAT Control for Space heating or cooling need to be set on the user interface. It can be set in three ways: MODE SET/ONE ZONE/DOUBLE ZONE. The indoor unit can be connected to a high voltage room thermostat and a low voltage room thermostat. A hydraulic adapter box can also be connected. Another six thermostats can be connected to the hydraulic adapter box. Please refer to “ROOM THERMOSTAT in installation manual” for wiring.

5.2.1 One zone control

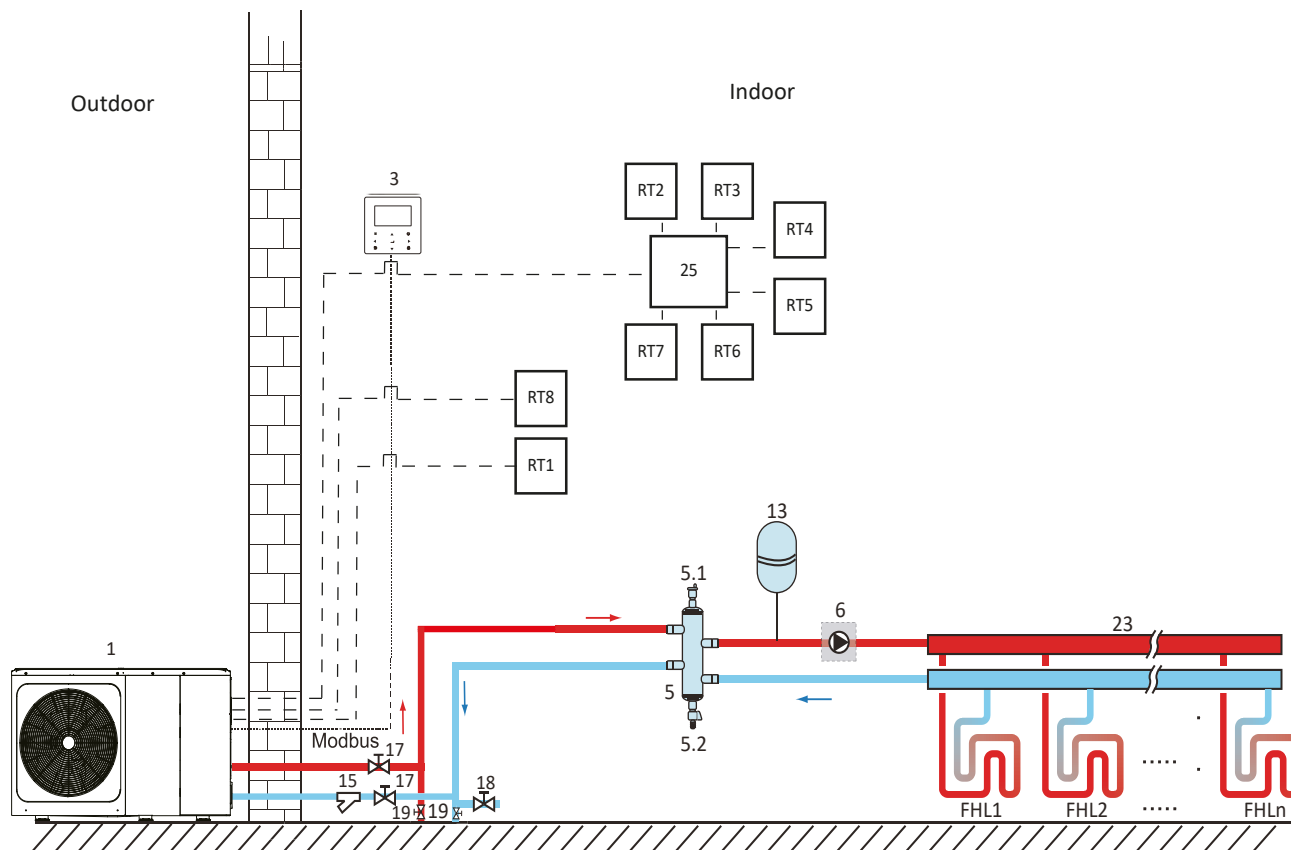

Figure 1-5.2: Application 2-One zone control

Legend			
1	Outdoor unit	17	Shut-off valve (Field supply)
3	User interface	18	Filling valve (Field supply)
5	Balance tank (Field supply)	19	Drainage valve (Field supply)
5.1	Automatic bleed valve	23	Collector/distributor (Field supply)
5.2	Drainage valve	25	Hydraulic adapter box (Optional)
6	P_o: Zone A circulation pump (Field supply)	RT 1...7	Low voltage room thermostat (Field supply)
13	Expansion vessel (Field supply)	RT8	High voltage room thermostat (Field supply)
15	Filter (Accessory)	FHL1...n	Floor heating loop (Field supply)

Notes:

1. The example is just for application illustration; please confirm the exact installation method according to the installation manual.

Space heating

One zone control: the unit ON/OFF is controlled by the room thermostat, cooling or heating mode and outlet water temperature is set on the user interface. System is ON when any “HL” of all the thermostats closes. When all “HL” open, system turns OFF.

The circulation pumps operation

When the system is ON, which means any “HL” of all the thermostats closes, P_o(6) starts running; When the system is OFF, which means all “HL” close, P_o (6) stops running.

Mono

5.2.2 Mode set control

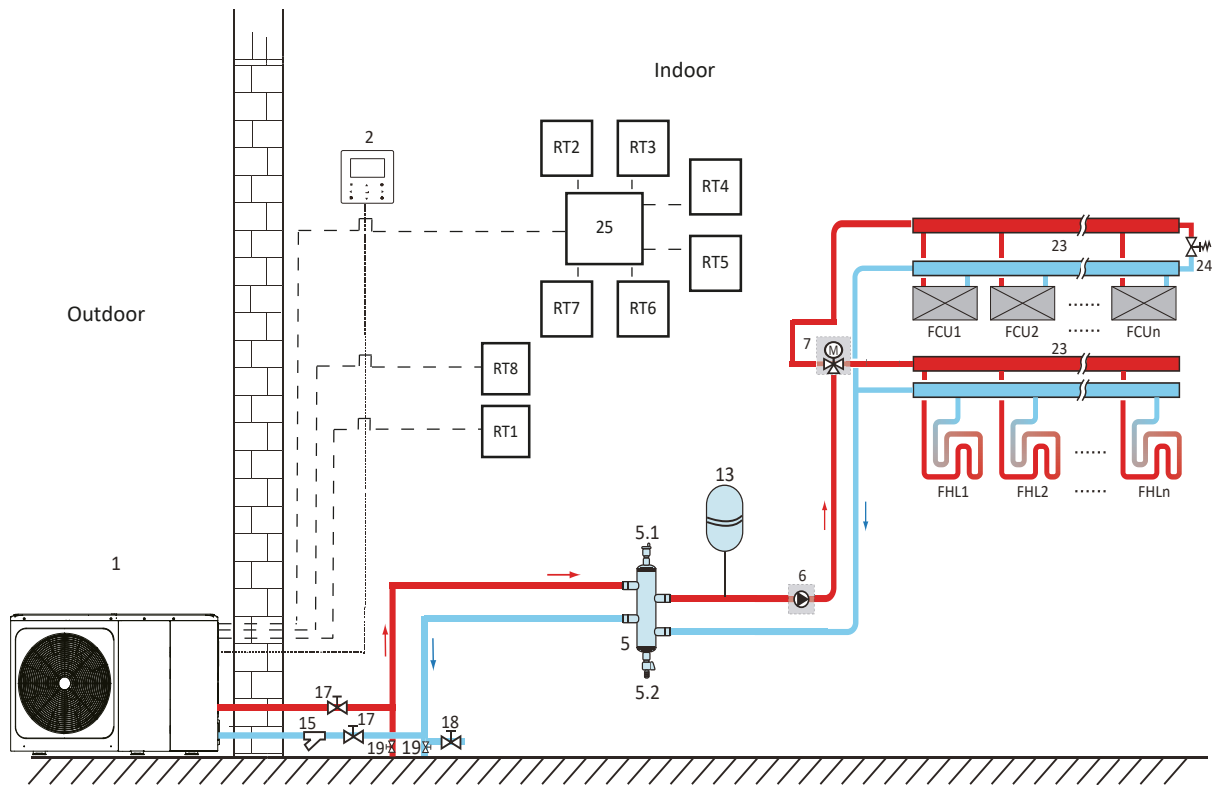

Figure 1-5.3: Application 2- Mode set control

Legend			
1	Outdoor unit	17	Shut-off valve (Field supply)
3	User interface	18	Filling valve (Field supply)
5	Balance tank (Field supply)	19	Drainage valve (Field supply)
5.1	Automatic bleed valve	23	Collector/distributor (Field supply)
5.2	Drainage valve	24	Bypass valve (Field supply)
6	P_o: Zone A circulation pump (Field supply)	25	Hydraulic adapter box (Optional)
7	SV2: 3-way valve (Field supply)	RT 1...7	Low voltage room thermostat (Field supply)
13	Expansion vessel (Field supply)	RT8	High voltage room thermostat (Field supply)
15	Filter (Accessory)	FHL1...n	Floor heating loop (Field supply)
		FCU1...n	Fan coil unit (Field supply)

Notes:

1. The example is just for application illustration; please confirm the exact installation method according to the installation manual.

Space heating

Cooling or heating mode is set via the room thermostat, water temperature is set on the user interface. 1) When any "CL" of all the thermostats close, system will be set at cooling mode. 2) When any "HL" of all the thermostats close and all "CL" open, system will be set at heating mode.

The circulation pumps operation

- 1) When the system is in cooling mode, which means any "CL" of all the thermostats closes, SV2(7) keeps OFF, P_o(6) starts running;
- 2) When the system is in heating mode, which means one or more "HL" close and all "CL" open, SV2(7) keeps ON, P_o(6) starts running.

5.2.3 Double zone control

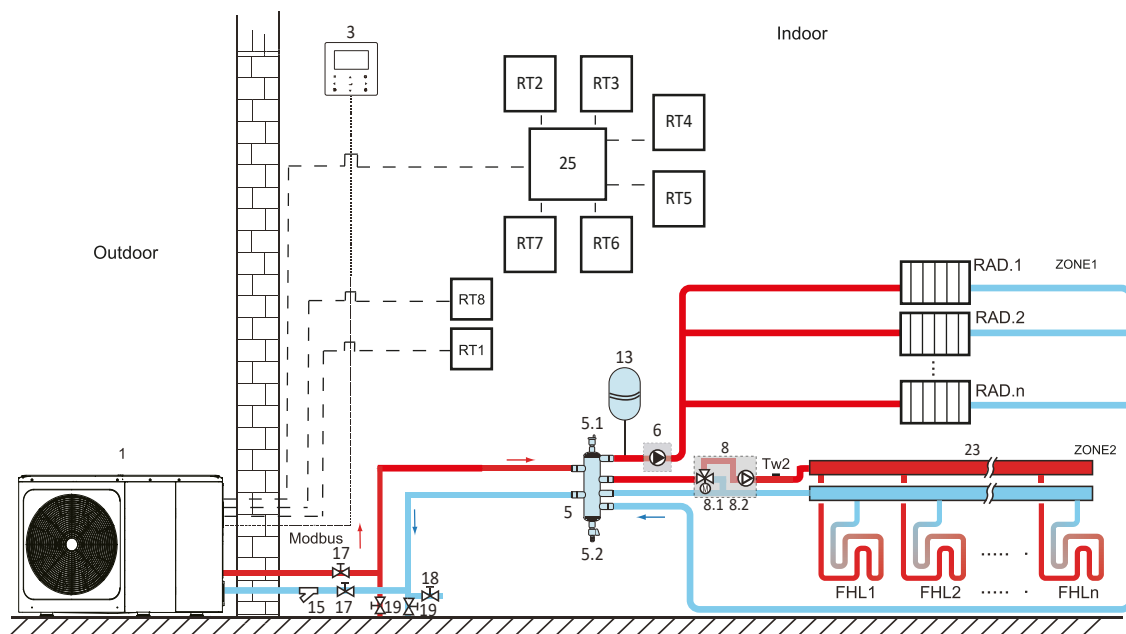

Figure 1-5.4: Application 2-Double zone control

Legend			
1	Outdoor unit	17	Shut-off valve (Field supply)
3	User interface	17	Shut-off valve (Field supply)
5	Balance tank (Field supply)	18	Filling valve (Field supply)
5.1	Automatic bleed valve	19	Drainage valve (Field supply)
5.2	Drainage valve	23	Collector/distributor (Field supply)
6	P_o: Zone A circulation pump (Field supply)	25	Hydraulic adapter box (Optional)
8	Mixing station (Field supply)	RT 1...7	Low voltage room thermostat (Field supply)
8.1	SV3: Mixing valve (Field supply)	RT8	High voltage room thermostat (Field supply)
8.2	P_c: zone 2 circulation	FHL1...n	Floor heating loop (Field supply)
13	Expansion vessel (Field supply)	Tw2	Zone 2 water flow temperature sensor (Optional)
15	Filter (Accessory)	RAD.1...n	Radiator (Field supply)

Notes:

1. The example is just for application illustration; please confirm the exact installation method according to the installation manual.

Space heating

Zone1 can operate in cooling mode or heating mode, while zone2 can only operate in heating mode; While installation, for all thermostats in zone1, only “ H, L ” terminals need to be connected. For all thermostats in zone2, only “ C, L ” terminals need to be connected.

1) The ON/OFF of zone1 is controlled by the room thermostats in zone1. When any “HL” of all thermostats in zone1 closes, zone1 turns ON. When all “HL” turn OFF, zone1 turns OFF; Target temperature and operation mode are set on the user interface;

2) In heating mode, the ON/OFF of zone2 is controlled by the room thermostats in zone2. When any “CL” of all thermostats in zone2 closes, zone2 turns ON. When all “CL” open, zone2 turns OFF. Target temperature is set on the user interface; Zone 2 can only operate in heating mode. When cooling mode is set on the user interface, zone2 keeps in OFF status.

The circulation pump operation

When zone 1 is ON, P_o(6) starts running; When zone 1 is OFF, P_o(6) stops running;

When zone 2 is ON, SV3(8.1) is ON, P_c(8.2) starts running; When zone 2 is OFF, SV3(8.1) is OFF, P_c(8.2) stops running .

The floor heating loops require a lower water temperature in heating mode compared to radiators. To achieve these two set points, a mixing station is used to adapt the water temperature according to requirements of the floor heating loops. The radiators are directly connected to the unit water circuit and the floor heating loops are after the mixing station. The mixing station is controlled by the unit.

Mono

5.3 Application 3

5.3.1 Group control

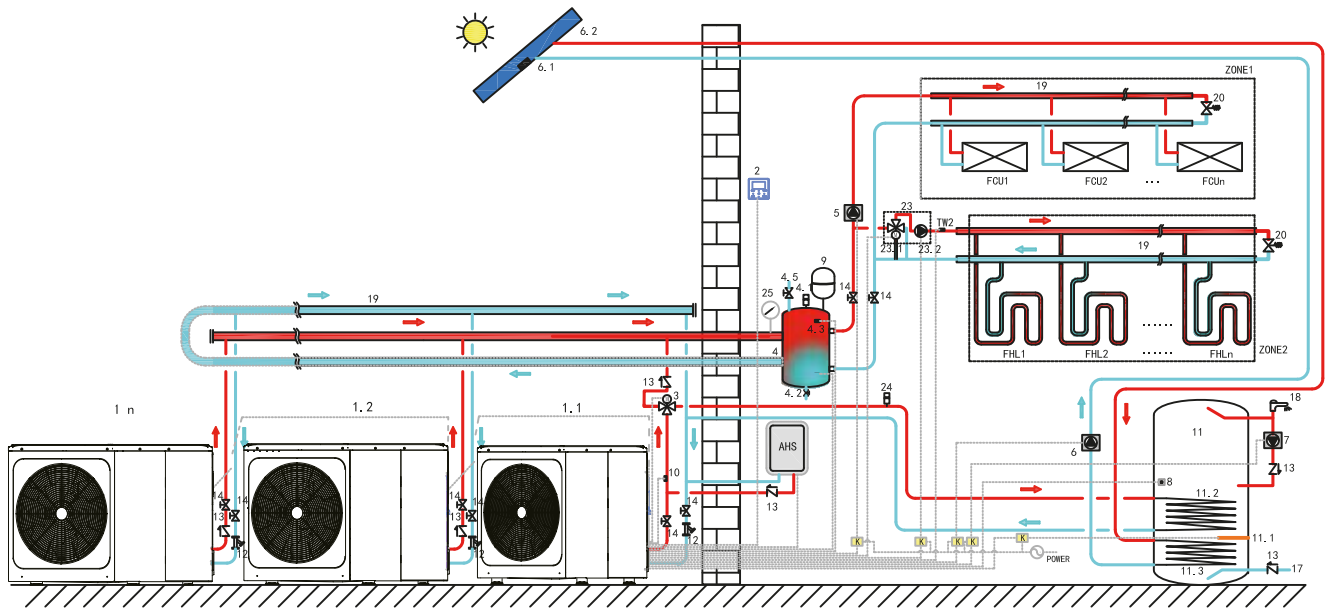

Figure 1-5.5: Application 3- Parallel system control

Legend			
1.1	Master unit	11.3	Coil 2: heat exchanger for heat pump
1.2...n	Slave unit	12	Filter(Accessory)
2	User interface	13	Check valve (Field supply)
3	SV1: 3-way valve(Field supply)	14	Shut-off valve(Field supply)
4	Balance tank(Field supply)	17	Tap water inlet pipe(Field supply)
4.1	Automatic bleed valve	18	Hot water tap(Field supply)
4.2	Drainage valve	19	Collector/Distributor(Field supply)
4.3	Tbt1: Balance tank upper temperature sensor(optional)	20	Bypass valve(Field supply)
4.5	Filling valve	23	Mixing station(Field supply)
5	P_O: Outside circulation pump (Field supply)	23.1	SV3: Mixing valve(Field supply)
6	P_S: Solar pump(Field supply)	23.2	P_C: Zone B circulation pump(Field supply)
6.1	Tsolar: Solar temperature sensor(Optional)	24	Automatic bleed valve(Field supply)
6.2	Solar panel (Field supply)	25	Water manometer(Field supply)
7	P_D: DHW pipe pump(Field supply)	Tw2	Zone B water flow temperature sensor(Optional)
8	T5: Domestic water tank temperature sensor(Accessory)	RAD 1...n	Radiator(Field supply)
9	Expansion vessel(Field supply)	FHL 1...n	Floor heating loop(Field supply)
10	T1: Total water flow temperature sensor(Optional)	K	Contactora(Field supply)
11	Domestic water tank(Field supply)	ZONE 1	The space operate cooling or heating mode
11.1	TBH: Domestic water tank heater	ZONE 2	The space operate heating mode
11.2	Coil 1: heat exchanger for heat pump	AHS	Auxiliary heat source(Field supply)

Notes:

1. The example is just for application illustration; please confirm the exact installation method according to the installation manual.

Modularity is perfect when an extension of capacity becomes required as the building cooling/heating demand evolves. 6 units can be controlled in group. The group control system can control and view the operation of the entire system only by connecting the master to the wire controller. If the DHW function is required, the water tank can only be connected to the master unit water circuit through a three-way valve, and controlled by the master unit. If AHS is needed, it can only be connected to the master waterway and controlled by the master unit. The Tbt1 temperature sensor must be installed in the parallel system (otherwise unit cannot be started). If the balance tank is too large, Tbt2 needs to be added in order to improve the control accuracy. Tbt2 is set in the lower part of the balance tank. The water inlet and outlet pipe joints of each unit of the parallel system should be connected with soft connections and one-way valves must be installed at the

water outlet pipe.

Space heating

All valve units can operate in space heating mode. The operation mode and setting temperature are set on the user interface(2). Due to changes of the outdoor temperature and the required load indoors, multiple outdoor units may operate at different times.

In cooling mode, SV3(23.1) and P_C(23.2) keep OFF, P_O(5) keeps ON;

In heating mode, when both ZONE 1 and ZONE 2 work, P_C(23.2) and P_O(5) keeps ON, SV3(23.1) switches between ON and OFF according to the set Tw2.

In heating mode, when only ZONE 1 works, P_O(5) keep ON, SV3(23.1) and P_C(23.2) keep OFF.

In heating mode, when only ZONE 2 works, P_O(5) keep OFF, P_C(23.2) keep ON, SV3(23.1) switches between ON and OFF according to the set Tw2.

Domestic water heating

Only master unit(1.1) can operate in DHW mode. T5S is set on the user interface(2). In DHW mode, SV1(3) keeps ON. When master unit operated in DHW mode, slave units can operate in space cooling/heating mode.

AHS control

AHS should be set via the dip switches on main board; AHS is only controlled by master unit. When master unit operates in DHW mode, AHS can only be used for producing domestic hot water; when master unit operates in heating mode, AHS can only be used for heating mode.

1) When AHS is set valid only for heating mode, it will be turned on in following conditions:

- a. Turn on BACKUPHEATER function on user interface;
- b. Master unit operates in heating mode. When inlet water temperature is too low or ambient temperature is too low, the target leaving water temperature is too high, AHS will be turned on automatically.

2) When the AHS is set valid for heating mode and DHW mode. It will be turned on in following conditions:

When master unit operates in heating mode, conditions of turning on AHS is same as 1);

When master unit operates in heating mode, if T5 or ambient temperature is too low, target T5 temperature is too high, AHS will be turned on automatically.

3)When AHS is valid, and the operation of AHS is controlled by M1M2.

When M1M2 closes, AHS is turned on. When master unit operates in DHW mode, AHS can not be turned on by closing M1M2.

TBH control

TBH should be set via the dip switches on main board. TBH is only controlled by master unit.

1) When the TBH is set to be valid, TBH can be turned on via TANKHEATER function on the user interface; In DHW mode, TBH will be turned on automatically when the initial domestic water temperature T5 is too low or the target domestic water temperature is too high at low ambient temperature.

2) When the TBH is set to be valid, M1M2 can be set to be valid on the user interface. TBH will be turned on if MIM2 dry contact closes.

Solar energy control

Solar energy is only controlled by master.

Hydraulic module recognizes solar energy signal by judging Tsolar or receiving SL1SL2 signal from user interface. The recognition method can be set via SOLAR INPUT on the user interface.

1)When Tsolar is set to be valid, Solar energy turns ON when Tsolar is high enough, P_s starts running; Solar energy turns OFF when Tsolar is low, P_s stops running.

2)When SL1SL2 control is set to be valid, Solar energy turns ON after receiving Solar kit signal from user interface, P_s starts running; Without solar kit signal. Solar energy turns OFF, P_s stops running.

Part 2

Engineering Data

1 SPECIFICATIONS	18
2 ELECTRICAL CHARACTERISTICS	22
3 DIMENSIONS AND CENTER OF GRAVITY	23
4 CAPACITY TABLES	24
5 OPERATING LIMITS.....	48
6 HYDRONIC PERFORMANCE	49
7 SOUND LEVELS.....	50
8 ACCESSORIES	54

1 Specifications

Outdoor unit model name			KHC-06RY1-B	KHC-08RY3-B	KHC-10RY3-B
Power supply	V/Ph/Hz		220-240/1/50	380-415/3/50	380-415/3/50
Heating A7W35	Capacity	kW	6.35	8.40	10.0
	Rated input	kW	1.28	1.63	2.02
	COP		4.95	5.15	4.95
Heating A7W45	Capacity	kW	6.30	8.10	10.0
	Rated input	kW	1.70	2.10	2.67
	COP		3.70	3.85	3.75
Heating A7W55	Capacity	kW	6.00	7.50	9.50
	Rated input	kW	2.03	2.36	3.06
	COP		2.95	3.18	3.10
Heating A-7W35	Capacity	kW	6.00	7.00	8.00
	Rated input	kW	2.00	2.19	2.62
	COP		3.00	3.20	3.05
Heating A-7W55	Capacity	kW	5.15	6.15	6.85
	Rated input	kW	2.58	3.00	3.43
	COP		2.00	2.05	2.00
Cooling A35W18	Capacity	kW	6.50	8.30	9.90
	Rated input	kW	1.35	1.64	2.18
	EER		4.80	5.05	4.55
Cooling A35W7	Capacity	kW	7.00	7.45	8.20
	Rated input	kW	2.33	2.22	2.52
	EER		3.00	3.35	3.25
Seasonal space heating energy efficiency class	Water outlet at 35° C		A+++		
	Water outlet at 55°C		A++		
SCOP	Warmer climate	35°C	6.57	6.99	7.09
		55°C	4.21	4.51	4.62
	Average climate	35°C	4.95	5.22	5.20
		55°C	3.52	3.37	3.47
	Colder climate	35°C	4.21	4.33	4.32
		55°C	2.85	2.88	2.99
SEER	Water outlet	7° C	5.31	5.82	5.95
		18° C	8.22	8.94	8.73
Sound power Level ²	dB	58	59	59	
Rated water flow	m ³ /h	1.09	1.44	1.44	
Water flow range	m ³ /h	0.4~1.25	0.4~1.65	0.4~1.65	
Internal water volume	L	3.31-8.11	3.49-8.29	3.49-8.29	
Backup electric heater	Capacity	kW	3	9	9
	Power supply	V/Ph/Hz	220-240/1/50	380-415/3/50	380-415/3/50
Compressor	Type		Twin rotary		
Outdoor fan	Motor type / Number of fans		DC fan / 1		

Outdoor unit model name		KHC-06RY1-B	KHC-08RY3-B	KHC-10RY3-B
Air side heat exchanger		Finned tube		
Refrigerant		R32 1.4kg		
Unit dimension (W × H × D)	mm	1295 × 718 × 429	1385 × 865 × 523	
Packing dimension (W × H × D)	mm	1375 × 885 × 475	1465 × 1035 × 560	
Net/Gross weight	kg	91/112	110/137	
Outdoor air temperature range	Cooling	°C	-5~43	
	Heating	°C	-25~35	
	DHW	°C	-25~43	
Water side heat exchanger		Plate type		
Water side connection		R1 "	R5/4"	R5/4"
Water setting temperature range	Cooling	°C	5~25	
	Heating	°C	25~65	
	DHW ³	°C	20~60	

Notes:

1. Relevant EU standards and legislation: EN14511; EN14825; EN50564; EN12102; (EU) No 811/2013; (EU) No 813/2013; OJ 2014/C 207/02.
2. Sound power test condition: EN12102-1
3. Maximum domestic hot water temperature 60°C is only available with TBH support.

Outdoor unit model name		KHC-12RY3-B	KHC-14RY3-B	KHC-16RY3-B	
Power supply	V/Ph/Hz	380-415/3/50	380-415/3/50	380-415/3/50	
Heating A7W35	Capacity	kW	12.1	14.5	15.9
	Rated input	kW	2.44	3.15	3.53
	COP		4.95	4.60	4.50
Heating A7W45	Capacity	kW	12.3	14.1	16.0
	Rated input	kW	3.32	3.92	4.57
	COP		3.70	3.60	3.50
Heating A7W55	Capacity	kW	11.9	13.8	16.0
	Rated input	kW	3.90	4.68	5.61
	COP		3.05	2.95	2.85
Heating A-7W35	Capacity	kW	10.00	12.00	13.10
	Rated input	kW	3.33	4.21	4.85
	COP		3.00	2.85	2.70
Heating A-7W55	Capacity	kW	9.80	11.00	12.50
	Rated input	kW	4.78	5.37	6.25
	COP		2.05	2.05	2.00
Cooling A35W18	Capacity	kW	12.00	13.50	14.2
	Rated input	kW	3.04	3.74	3.94
	EER		3.95	3.61	3.61
Cooling A35W7	Capacity	kW	11.5	12.4	14.0
	Rated input	kW	4.18	4.96	5.60
	EER		2.75	2.50	2.50
Seasonal space heating energy efficiency class	Water outlet at 35° C		A+++		
	Water outlet at 55°C		A++		
SCOP	Warmer climate	35°C	6.47	6.57	6.28
		55°C	4.42	4.49	4.47
	Average climate	35°C	4.81	4.72	4.62
		55°C	3.45	3.47	3.41
	Colder climate	35°C	4.08	4.07	4.02
		55°C	3.02	3.05	3.12
SEER	Water outlet	7° C	4.90	4.85	4.67
		18° C	7.07	6.89	6.70
Sound power Level ²		dB	65	65	68
Rated water flow		m ³ /h	2.08	2.49	2.73
Water flow range		m ³ /h	0.7~2.5	0.7~2.75	0.7~3.0
Internal water volume		L	3.83-8.63	3.83-8.63	3.83-8.63
Backup electric heater	Capacity	kW	9	9	9
	Power supply	V/Ph/Hz	380-415/3/50	380-415/3/50	380-415/3/50
Compressor	Type		Twin rotary		
Outdoor fan	Motor type / Number of fans		DC fan / 1		

Outdoor unit model name		KHC-12RY3-B	KHC-14RY3-B	KHC-16RY3-B
Air side heat exchanger		Finned tube		
Refrigerant		R32 1.75kg		
Unit dimension (W × H × D)	mm	1385×865×523		
Packing dimension (W × H × D)	mm	1465×1035×560		
Net/Gross weight	kg	149/177		
Outdoor air temperature range	Cooling	°C	-5~43	
	Heating	°C	-25~35	
	DHW	°C	-25~43	
Water side heat exchanger		Plate type		
Water side connection		R5/4"		
Water setting temperature range	Cooling	°C	5~25	
	Heating	°C	25~65	
	DHW ³	°C	20~60	

Notes:

1. Relevant EU standards and legislation: EN14511; EN14825; EN50564; EN12102; (EU) No 811/2013; (EU) No 813/2013; OJ 2014/C 207/02.
2. Sound power test condition: EN12102-1
3. Maximum domestic hot water temperature 60°C is only available with TBH support.

2 Electrical characteristics

System	Outdoor unit				Power current			Compressor		Fan	
	Voltage (V)	Hz	Min. (V)	Max. (V)	MCA (A)	TOCA (A)	MFA (A)	MSC (A)	RLA (A)	kW	FLA (A)
KHC-06RY1-B	220~240	50	198	264	27	31	38	/	13.5	0.10	0.5
KHC-08RY3-B	380~415	50	342	456	29	32	38	/	14.5	0.17	1.5
KHC-10RY3-B	380~415	50	342	456	30	32	38	/	15.5	0.17	1.5
KHC-12RY3-B	380~415	50	342	456	23	27	29	/	9.15	0.17	1.5
KHC-14RY3-B	380~415	50	342	456	24	27	29	/	10.15	0.17	1.5
KHC-16RY3-B	380~415	50	342	456	25	27	29	/	11.15	0.17	1.5

Note:

MCA: Min. Circuit Amps. (A)

TOCA: Total Over-current Amps. (A)

MFA: Max. Fuse Amps. (A)

MSC: Max. Starting Amps. (A)

RLA: Rated Load Amps. (A)

The input Amps of compressor where MAX. Hz can operate for nominal cooling or heating test condition

kW: Rated Motor Output

FLA: Full Load Amps. (A)

3 Dimensions and Center of Gravity

6kW models

Figure 2-3.1: KHC-06RY1-B dimensions and center of gravity (unit: mm)

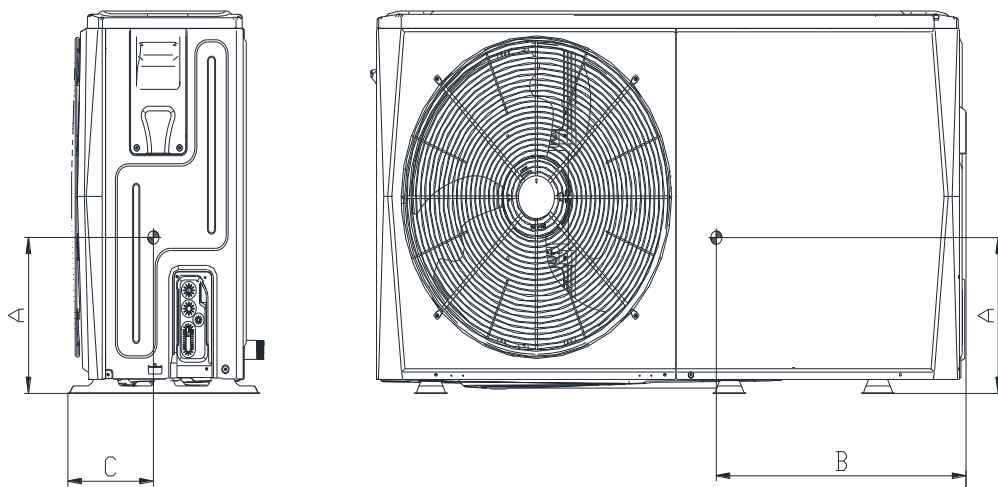

Model	A	B	C
6kW	295	540	190

unit: mm

8/10/12/14/16kW models

Figure 2-3.2: KHC-08RY3-B, KHC-10RY3-B, KHC-12RY3-B, KHC-14RY3-B, KHC-16RY3-B dimensions and center of gravity (unit: mm)

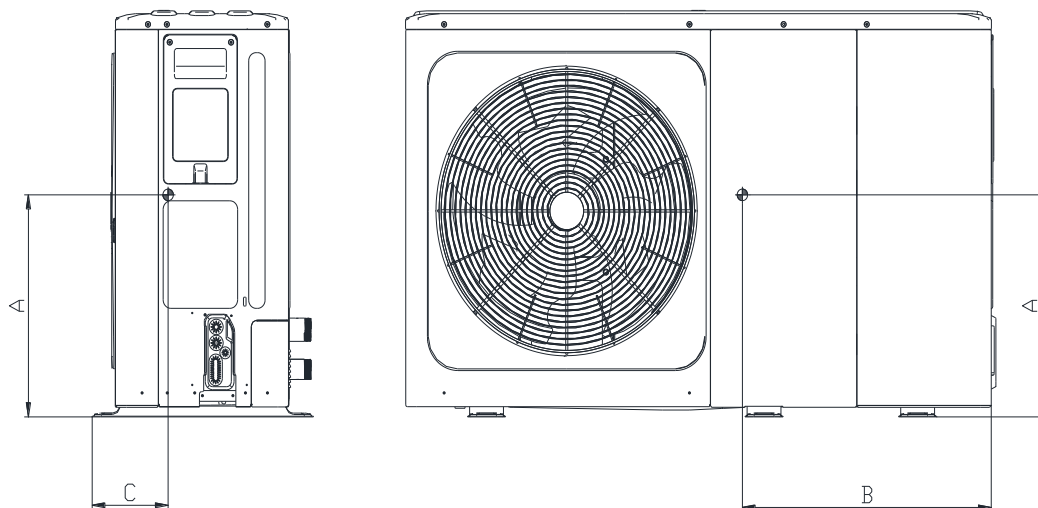

Model	A	B	C
8/10kW	330	580	280
12-16kW	200	605	245

unit: mm

4 Capacity Tables

4.1 Heating Capacity Tables (Test standard: EN14511)

Table 2-4.1-1: Heating capacity for 6kW models

Maximum																
DB	LWT															
	25			30			35			40			45			
	HC	PI	COP	HC	PI	COP	HC	PI	COP	HC	PI	COP	HC	PI	COP	
-25	2.57	1.49	1.72	2.25	1.53	1.46	2.14	1.67	1.28	1.91	1.64	1.17	1.71	1.57	1.09	
-20	3.64	1.56	2.34	3.34	1.86	1.80	2.88	2.03	1.42	2.56	2.08	1.23	2.33	2.08	1.12	
-15	4.43	1.49	2.97	4.19	1.53	2.73	4.00	1.71	2.34	3.61	1.87	1.93	3.08	2.01	1.53	
-10	5.75	1.69	3.41	5.50	1.84	2.99	5.11	1.99	2.57	4.83	2.18	2.22	4.64	2.24	2.07	
-7	6.55	1.77	3.71	6.30	1.92	3.28	6.21	2.17	2.86	5.79	2.32	2.50	5.57	2.38	2.35	
-5	6.54	1.64	3.98	6.32	1.79	3.52	6.25	2.02	3.09	5.97	2.18	2.74	5.84	2.30	2.54	
-2	6.32	1.49	4.24	6.14	1.58	3.88	6.11	1.80	3.40	6.07	2.04	2.97	6.01	2.26	2.65	
0	6.49	1.34	4.85	6.37	1.48	4.31	6.35	1.68	3.79	6.50	1.99	3.26	6.35	2.25	2.82	
2	6.68	1.35	4.96	6.48	1.48	4.38	6.53	1.69	3.86	6.65	1.89	3.52	6.58	2.23	2.95	
5	7.04	1.31	5.37	6.81	1.51	4.51	6.88	1.62	4.25	6.96	1.89	3.69	6.99	2.12	3.29	
7	7.58	1.29	5.87	7.46	1.55	4.81	7.41	1.56	4.76	7.13	1.79	3.99	7.13	2.00	3.58	
10	7.43	1.21	6.12	7.27	1.39	5.24	7.35	1.46	5.02	7.37	1.75	4.21	7.32	1.93	3.78	
12	7.33	1.17	6.25	7.26	1.31	5.54	7.34	1.42	5.16	7.51	1.70	4.42	7.40	1.86	3.98	
14	7.25	1.15	6.31	7.22	1.27	5.69	7.30	1.39	5.23	7.54	1.67	4.52	7.41	1.82	4.08	
15	7.17	1.13	6.35	7.20	1.24	5.82	7.26	1.38	5.28	7.58	1.64	4.61	7.43	1.78	4.16	
19	6.98	1.00	6.99	7.01	1.13	6.19	7.04	1.22	5.78	7.28	1.56	4.68	7.42	1.70	4.37	
20	6.93	0.97	7.15	6.97	1.11	6.28	6.98	1.18	5.91	7.21	1.54	4.70	7.42	1.68	4.42	
25	6.69	0.80	8.32	6.74	0.94	7.16	6.70	1.06	6.31	6.65	1.30	5.11	7.21	1.52	4.74	
30	6.74	0.71	9.53	6.83	0.85	8.02	6.83	0.94	7.27	6.56	1.09	6.01	7.05	1.40	5.05	
35	6.79	0.66	10.34	6.93	0.73	9.43	6.96	0.85	8.17	6.47	0.94	6.87	6.89	1.27	5.42	
40	7.26	0.64	11.42	7.37	0.73	10.15	7.28	0.81	9.02	7.12	0.97	7.34	7.34	1.20	6.12	
43	7.54	0.63	12.01	7.64	0.70	10.94	7.48	0.76	9.87	7.51	0.91	8.27	7.61	1.08	7.02	
DB	LWT															
	50			55			58			60			65			
	HC	PI	COP	HC	PI	COP	HC	PI	COP	HC	PI	COP	HC	PI	COP	
-25	/	/	/	/	/	/	/	/	/	/	/	/	/	/	/	
-20	2.19	2.04	1.07	1.84	1.86	0.99	1.63	1.74	0.94	/	/	/	/	/	/	
-15	2.70	2.02	1.34	2.26	1.88	1.20	2.18	1.96	1.11	2.13	2.02	1.05	/	/	/	
-10	4.13	2.41	1.72	3.80	2.24	1.69	3.51	2.28	1.54	3.32	2.30	1.44	/	/	/	
-7	5.29	2.63	2.01	5.22	2.66	1.96	4.83	2.63	1.84	4.57	2.61	1.75	/	/	/	
-5	5.44	2.44	2.23	5.31	2.64	2.01	4.96	2.61	1.90	4.73	2.59	1.83	/	/	/	
-2	5.59	2.38	2.35	5.31	2.60	2.04	5.05	2.58	1.96	4.88	2.57	1.90	/	/	/	
0	5.88	2.37	2.48	5.42	2.59	2.09	5.21	2.56	2.03	5.06	2.54	1.99	/	/	/	
2	6.05	2.38	2.54	5.69	2.36	2.41	5.48	2.50	2.19	5.33	2.61	2.05	/	/	/	
5	6.37	2.27	2.81	6.11	2.46	2.48	5.89	2.50	2.36	5.74	2.53	2.27	4.92	2.68	1.84	
7	6.87	2.16	3.17	6.90	2.37	2.91	6.61	2.46	2.69	6.42	2.52	2.55	5.25	2.60	2.02	
10	7.01	2.09	3.35	6.93	2.28	3.04	6.53	2.35	2.78	6.27	2.41	2.60	5.57	2.52	2.21	
12	7.15	2.03	3.52	6.99	2.20	3.18	6.50	2.27	2.86	6.17	2.32	2.65	5.86	2.45	2.39	
14	7.19	1.99	3.60	6.98	2.15	3.24	6.44	2.22	2.91	6.09	2.27	2.68	5.98	2.41	2.48	
15	7.24	1.97	3.67	6.98	2.12	3.30	6.40	2.18	2.94	6.01	2.23	2.70	6.10	2.39	2.56	
19	7.27	1.84	3.95	6.84	1.93	3.54	6.33	1.97	3.21	5.98	2.00	2.99	6.60	2.30	2.88	
20	7.28	1.81	4.02	6.81	1.89	3.60	6.31	1.92	3.28	5.98	1.95	3.06	/	/	/	
25	7.33	1.66	4.43	6.63	1.66	4.00	6.22	1.67	3.73	5.94	1.67	3.55	/	/	/	
30	6.91	1.40	4.92	6.60	1.57	4.21	6.25	1.57	3.98	6.01	1.57	3.83	/	/	/	
35	6.49	1.24	5.21	6.57	1.48	4.45	/	/	/	/	/	/	/	/	/	
40	6.93	1.22	5.68	/	/	/	/	/	/	/	/	/	/	/	/	
43	7.19	1.21	5.96	/	/	/	/	/	/	/	/	/	/	/	/	

Abbreviations:

LWT: Leaving water temperature (°C)

DB: Dry-bulb temperature for Outdoor air temperature (°C)

HC: Total heating capacity (kW)

PI: Power input (kW)

Table 2-4.1-2: Heating capacity for 6kW models

Normal															
DB	LWT														
	25			30			35			40			45		
	HC	PI	COP	HC	PI	COP	HC	PI	COP	HC	PI	COP	HC	PI	COP
-25	2.37	1.35	1.76	2.07	1.37	1.51	1.95	1.50	1.30	1.77	1.51	1.17	1.61	1.49	1.08
-20	3.33	1.37	2.43	3.04	1.65	1.85	2.60	1.78	1.46	2.34	1.87	1.25	2.16	1.92	1.13
-15	4.01	1.29	3.11	3.77	1.33	2.83	3.57	1.47	2.43	3.27	1.65	1.98	2.73	1.76	1.56
-10	5.15	1.43	3.61	4.89	1.57	3.12	4.51	1.69	2.66	4.33	1.91	2.27	4.21	2.01	2.10
-7	6.24	1.62	3.86	6.05	1.80	3.36	6.00	2.00	3.00	5.61	2.21	2.54	5.40	2.25	2.40
-5	5.94	1.42	4.17	5.89	1.62	3.63	5.72	1.79	3.19	5.65	1.97	2.87	5.50	2.11	2.61
-2	5.78	1.32	4.39	5.69	1.43	3.97	5.55	1.58	3.51	5.64	1.82	3.10	5.51	2.00	2.75
0	5.99	1.20	4.98	5.86	1.33	4.40	5.74	1.47	3.89	5.94	1.75	3.40	5.68	1.93	2.94
2	6.15	1.20	5.11	5.87	1.31	4.50	5.50	1.41	3.90	5.95	1.65	3.61	5.80	1.93	3.00
5	6.43	1.16	5.56	6.06	1.31	4.64	6.16	1.39	4.42	6.36	1.68	3.78	6.13	1.78	3.45
7	6.75	1.09	6.18	6.27	1.20	5.21	6.35	1.28	4.95	6.44	1.55	4.14	6.30	1.70	3.70
10	6.68	1.02	6.52	6.32	1.15	5.49	6.49	1.26	5.17	6.59	1.50	4.39	6.62	1.73	3.83
12	6.62	0.98	6.74	6.37	1.08	5.88	6.51	1.21	5.38	6.83	1.46	4.66	6.83	1.67	4.09
14	6.56	0.95	6.87	6.36	1.04	6.09	6.48	1.18	5.50	6.91	1.44	4.82	6.89	1.63	4.23
15	6.52	0.94	6.93	6.37	1.02	6.24	6.48	1.16	5.57	7.03	1.43	4.92	6.98	1.61	4.32
19	6.37	0.83	7.67	6.24	0.93	6.68	6.31	1.03	6.14	6.65	1.32	5.02	6.85	1.50	4.56
20	6.34	0.81	7.85	6.20	0.91	6.79	6.27	1.00	6.28	6.55	1.30	5.05	6.82	1.48	4.62
25	5.97	0.65	9.21	6.12	0.78	7.79	6.13	0.91	6.75	6.15	1.11	5.53	6.76	1.35	4.99
30	6.04	0.57	10.62	6.24	0.71	8.79	6.29	0.80	7.84	6.10	0.93	6.55	6.64	1.24	5.35
35	6.14	0.53	11.60	6.38	0.61	10.41	6.46	0.73	8.87	6.07	0.81	7.54	6.55	1.13	5.79
40	6.66	0.52	12.89	6.67	0.59	11.28	6.57	0.67	9.86	6.49	0.80	8.11	6.78	1.03	6.59
43	6.97	0.51	13.65	6.98	0.57	12.24	6.80	0.63	10.86	6.91	0.75	9.20	7.09	0.93	7.61
DB	LWT														
	50			55			58			60			65		
	HC	PI	COP	HC	PI	COP	HC	PI	COP	HC	PI	COP	HC	PI	COP
-25	/	/	/	/	/	/	/	/	/	/	/	/	/	/	/
-20	2.04	1.88	1.08	1.77	1.78	1.00	1.61	1.71	0.94	/	/	/	/	/	/
-15	2.41	1.76	1.37	2.08	1.70	1.22	2.02	1.80	1.12	1.98	1.88	1.05	/	/	/
-10	3.76	2.15	1.75	3.46	2.03	1.71	3.22	2.08	1.55	3.06	2.13	1.44	/	/	/
-7	5.07	2.45	2.07	5.15	2.58	2.00	4.63	2.47	1.87	4.28	2.39	1.79	/	/	/
-5	5.11	2.25	2.27	5.08	2.47	2.06	4.64	2.40	1.93	4.35	2.35	1.85	/	/	/
-2	5.17	2.17	2.39	5.06	2.44	2.07	4.69	2.37	1.98	4.44	2.32	1.91	/	/	/
0	5.36	2.12	2.53	5.15	2.44	2.11	4.80	2.35	2.04	4.56	2.29	1.99	/	/	/
2	5.73	2.18	2.63	5.65	2.31	2.45	5.25	2.36	2.23	4.99	2.40	2.08	/	/	/
5	5.91	2.04	2.89	5.80	2.28	2.54	5.45	2.28	2.39	5.22	2.28	2.29	4.23	2.21	1.91
7	6.13	1.86	3.29	6.00	2.03	2.95	5.79	2.10	2.76	5.64	2.17	2.60	4.40	2.06	2.14
10	6.47	1.88	3.44	6.04	1.94	3.11	5.87	2.07	2.83	5.76	2.17	2.65	4.54	1.94	2.34
12	6.64	1.82	3.66	6.12	1.87	3.27	5.86	1.99	2.94	5.70	2.09	2.73	4.81	1.88	2.56
14	6.69	1.77	3.78	6.12	1.82	3.36	5.83	1.94	3.01	5.63	2.03	2.77	4.91	1.83	2.68
15	6.76	1.75	3.86	6.15	1.80	3.42	5.81	1.91	3.04	5.59	2.00	2.79	5.04	1.82	2.77
19	6.82	1.63	4.18	6.06	1.64	3.69	5.77	1.76	3.29	5.58	1.85	3.02	5.55	1.77	3.14
20	6.84	1.61	4.25	6.03	1.60	3.76	5.76	1.72	3.35	5.58	1.82	3.07	/	/	/
25	7.01	1.49	4.72	5.99	1.43	4.20	5.79	1.51	3.83	5.65	1.57	3.59	/	/	/
30	6.64	1.26	5.28	6.00	1.35	4.46	5.85	1.42	4.13	5.75	1.47	3.91	/	/	/
35	6.29	1.12	5.63	6.02	1.27	4.75	/	/	/	/	/	/	/	/	/
40	6.53	1.06	6.19	/	/	/	/	/	/	/	/	/	/	/	/
43	6.84	1.05	6.54	/	/	/	/	/	/	/	/	/	/	/	/

Abbreviations:

LWT: Leaving water temperature (°C)

DB: Dry-bulb temperature for Outdoor air temperature (°C)

HC: Total heating capacity (kW)

PI: Power input (kW)

Table 2-4.1-3: Heating capacity for 6kW models

Minimum															
DB	LWT														
	25			30			35			40			45		
	HC	PI	COP	HC	PI	COP	HC	PI	COP	HC	PI	COP	HC	PI	COP
-25	1.54	0.86	1.78	1.39	0.91	1.53	1.48	1.12	1.32	1.36	1.14	1.19	1.08	0.99	1.09
-20	2.04	0.82	2.47	1.80	0.96	1.88	1.67	1.12	1.49	1.64	1.28	1.28	1.45	1.27	1.14
-15	2.07	0.65	3.18	2.03	0.70	2.90	1.90	0.76	2.49	2.02	0.99	2.03	1.97	1.25	1.58
-10	2.28	0.62	3.71	2.14	0.67	3.21	2.02	0.74	2.74	2.51	1.07	2.34	2.81	1.32	2.14
-7	1.57	0.39	4.03	1.45	0.41	3.50	1.48	0.48	3.06	2.49	0.92	2.72	2.67	1.08	2.48
-5	1.78	0.41	4.32	1.66	0.44	3.76	1.70	0.52	3.30	2.59	0.87	2.98	2.82	1.08	2.61
-2	1.71	0.38	4.55	1.68	0.41	4.13	1.69	0.46	3.63	2.69	0.84	3.19	2.88	1.04	2.78
0	1.74	0.34	5.15	1.82	0.40	4.58	1.77	0.44	4.02	2.93	0.84	3.47	3.02	1.00	3.01
2	2.01	0.38	5.35	2.06	0.44	4.69	2.04	0.48	4.22	3.04	0.81	3.78	3.13	0.94	3.32
5	2.31	0.40	5.78	2.32	0.48	4.82	2.33	0.51	4.59	3.21	0.82	3.93	3.29	0.93	3.54
7	2.71	0.42	6.44	2.65	0.49	5.37	2.73	0.51	5.32	3.36	0.78	4.32	3.85	0.99	3.88
10	2.27	0.33	6.83	2.08	0.36	5.75	2.32	0.43	5.42	3.32	0.72	4.60	3.96	0.99	3.99
12	2.56	0.36	7.08	2.47	0.40	6.19	2.60	0.46	5.67	3.48	0.71	4.91	4.12	0.96	4.27
14	2.68	0.37	7.25	2.64	0.41	6.43	2.71	0.47	5.82	3.53	0.69	5.09	4.16	0.94	4.43
15	2.81	0.38	7.31	2.83	0.43	6.59	2.84	0.48	5.89	3.60	0.69	5.20	4.22	0.93	4.53
19	3.06	0.38	8.10	3.30	0.47	7.06	3.53	0.54	6.50	4.35	0.82	5.31	4.52	0.94	4.79
20	3.12	0.38	8.30	3.41	0.48	7.18	3.70	0.56	6.65	4.54	0.85	5.34	4.60	0.95	4.86
25	3.68	0.38	9.73	3.97	0.48	8.24	4.22	0.59	7.15	4.85	0.83	5.85	5.19	0.99	5.24
30	3.88	0.35	11.23	4.20	0.45	9.30	4.47	0.54	8.30	4.49	0.65	6.94	5.18	0.92	5.63
35	4.55	0.37	12.27	4.71	0.43	11.02	4.57	0.49	9.40	4.46	0.56	7.99	5.10	0.84	6.09
40	4.93	0.36	13.64	4.94	0.41	11.94	5.17	0.49	10.45	5.12	0.60	8.59	5.58	0.81	6.92
43	5.20	0.36	14.44	5.20	0.40	12.96	5.39	0.47	11.51	5.48	0.56	9.75	5.93	0.74	8.00
DB	LWT														
	50			55			58			60			65		
	HC	PI	COP	HC	PI	COP	HC	PI	COP	HC	PI	COP	HC	PI	COP
-25	/	/	/	/	/	/	/	/	/	/	/	/	/	/	/
-20	1.51	1.38	1.09	1.34	1.34	1.01	1.25	1.31	0.95	/	/	/	/	/	/
-15	1.86	1.35	1.39	1.53	1.24	1.24	1.52	1.34	1.14	1.51	1.41	1.07	/	/	/
-10	2.80	1.57	1.78	2.63	1.51	1.74	2.48	1.57	1.58	2.38	1.63	1.47	/	/	/
-7	2.57	1.22	2.11	2.64	1.27	2.08	2.66	1.40	1.90	2.68	1.47	1.82	/	/	/
-5	2.59	1.10	2.35	2.81	1.33	2.11	2.75	1.39	1.98	2.72	1.43	1.90	/	/	/
-2	2.75	1.12	2.46	2.80	1.31	2.13	2.83	1.40	2.03	2.85	1.45	1.96	/	/	/
0	2.99	1.15	2.59	2.85	1.31	2.17	2.94	1.41	2.09	3.00	1.47	2.04	/	/	/
2	3.18	1.17	2.73	3.13	1.24	2.52	3.21	1.39	2.30	3.26	1.51	2.16	/	/	/
5	3.43	1.15	2.98	3.46	1.32	2.62	3.53	1.43	2.46	3.58	1.52	2.36	2.85	1.42	2.01
7	4.26	1.25	3.41	4.38	1.41	3.10	4.29	1.50	2.85	4.23	1.57	2.69	3.33	1.49	2.24
10	4.22	1.18	3.57	4.37	1.35	3.23	4.27	1.45	2.94	4.20	1.53	2.75	3.55	1.46	2.43
12	4.37	1.15	3.82	4.73	1.39	3.41	4.48	1.47	3.04	4.32	1.55	2.79	3.72	1.39	2.67
14	4.40	1.11	3.96	4.86	1.38	3.52	4.55	1.47	3.10	4.34	1.54	2.82	3.77	1.34	2.80
15	4.46	1.10	4.05	5.03	1.40	3.58	4.65	1.49	3.13	4.39	1.56	2.82	3.84	1.33	2.90
19	4.68	1.07	4.38	4.65	1.20	3.88	4.31	1.25	3.44	4.08	1.30	3.15	4.14	1.26	3.28
20	4.73	1.06	4.46	4.56	1.15	3.95	4.23	1.20	3.52	4.00	1.24	3.23	/	/	/
25	5.50	1.11	4.96	4.76	1.08	4.41	4.51	1.12	4.03	4.34	1.15	3.78	/	/	/
30	5.35	0.96	5.55	4.91	1.05	4.69	4.69	1.08	4.34	4.54	1.10	4.11	/	/	/
35	5.19	0.88	5.92	5.13	1.03	4.99	/	/	/	/	/	/	/	/	/
40	5.61	0.86	6.50	/	/	/	/	/	/	/	/	/	/	/	/
43	5.97	0.87	6.87	/	/	/	/	/	/	/	/	/	/	/	/

Abbreviations:

LWT: Leaving water temperature (°C)

DB: Dry-bulb temperature for Outdoor air temperature (°C)

HC: Total heating capacity (kW)

PI: Power input (kW)

Table 2-4.2-1: Heating capacity for 8kW models

Maximum															
DB	LWT														
	25			30			35			40			45		
	HC	PI	COP	HC	PI	COP	HC	PI	COP	HC	PI	COP	HC	PI	COP
-25	4.45	1.98	2.25	4.00	2.04	1.96	3.59	2.19	1.64	3.34	2.15	1.55	2.81	2.17	1.30
-20	5.68	2.03	2.80	5.09	2.15	2.37	4.74	2.24	2.11	4.32	2.44	1.77	3.70	2.29	1.61
-15	6.90	2.07	3.34	6.44	2.24	2.87	6.11	2.51	2.43	5.57	2.47	2.26	5.29	2.65	2.00
-10	7.45	2.02	3.68	7.28	2.18	3.33	7.08	2.25	3.15	6.87	2.63	2.62	6.77	2.74	2.47
-7	7.64	2.03	3.76	7.47	2.20	3.40	7.27	2.29	3.17	7.05	2.64	2.67	6.94	2.76	2.52
-5	8.05	2.00	4.02	7.97	2.16	3.69	7.69	2.39	3.22	7.45	2.57	2.90	7.44	2.77	2.69
-2	5.03	1.18	4.25	4.94	1.27	3.89	4.96	1.39	3.57	5.61	1.82	3.08	5.67	2.04	2.78
0	8.55	1.79	4.77	8.49	2.01	4.23	8.42	2.23	3.77	8.40	2.53	3.32	8.09	2.75	2.94
2	8.66	1.67	5.20	8.65	1.92	4.50	8.48	2.14	3.95	8.50	2.50	3.40	8.31	2.74	3.04
5	9.03	1.52	5.95	8.95	1.81	4.94	8.86	1.94	4.56	8.78	2.29	3.84	8.69	2.57	3.38
7	9.51	1.45	6.54	9.20	1.73	5.32	9.11	1.80	5.07	8.85	2.12	4.18	8.98	2.35	3.82
10	10.06	1.35	7.44	9.28	1.59	5.84	8.94	1.65	5.42	8.70	2.02	4.30	8.74	2.24	3.90
12	10.00	1.23	8.13	9.37	1.45	6.48	9.05	1.58	5.74	8.92	1.89	4.72	8.86	2.14	4.15
14	9.92	1.16	8.53	9.38	1.37	6.83	9.06	1.53	5.93	8.99	1.81	4.96	8.88	2.07	4.30
15	9.86	1.12	8.79	9.39	1.33	7.09	9.09	1.51	6.04	9.07	1.77	5.12	8.91	2.03	4.38
19	9.69	0.98	9.87	9.48	1.17	8.08	9.28	1.35	6.88	9.69	0.98	9.87	9.05	1.85	4.89
20	9.65	0.95	10.14	9.51	1.14	8.33	9.33	1.32	7.09	9.45	1.59	5.93	9.08	1.81	5.02
25	9.42	0.90	10.44	9.00	1.03	8.75	8.75	1.15	7.64	9.15	1.44	6.34	9.01	1.55	5.80
30	9.18	0.83	11.03	8.49	0.93	9.16	8.17	1.05	7.78	8.85	1.29	6.84	8.93	1.43	6.23
35	9.55	0.84	11.31	8.83	0.93	9.45	8.50	1.06	8.05	9.20	1.31	7.05	9.29	1.46	6.34
40	10.03	0.87	11.57	9.27	0.93	10.02	8.92	1.05	8.49	9.66	1.32	7.31	9.75	1.51	6.46
43	10.33	0.84	12.25	9.55	0.85	11.27	9.19	1.01	9.11	9.95	1.27	7.86	10.04	1.47	6.83
DB	LWT														
	50			55			58			60			65		
	HC	PI	COP	HC	PI	COP	HC	PI	COP	HC	PI	COP	HC	PI	COP
-25	/	/	/	/	/	/	/	/	/	/	/	/	/	/	/
-20	3.17	2.26	1.41	2.62	2.10	1.25	2.28	1.98	1.15	/	/	/	/	/	/
-15	4.67	2.70	1.73	4.94	2.92	1.69	4.37	2.87	1.52	3.99	2.84	1.41	/	/	/
-10	6.32	2.88	2.20	6.07	3.05	1.99	5.54	2.94	1.88	5.19	2.86	1.81	/	/	/
-7	6.48	2.89	2.24	6.22	3.07	2.03	5.68	2.96	1.92	5.32	2.88	1.85	/	/	/
-5	7.35	2.99	2.46	6.45	2.94	2.19	6.20	2.97	2.09	6.04	3.00	2.02	/	/	/
-2	5.68	2.24	2.54	5.28	2.35	2.24	5.18	2.44	2.12	5.11	2.51	2.04	/	/	/
0	8.11	2.95	2.75	7.10	2.99	2.38	6.95	3.09	2.25	6.85	3.16	2.17	/	/	/
2	8.18	2.90	2.82	7.26	2.83	2.56	7.05	3.01	2.34	6.91	3.14	2.20	/	/	/
5	8.30	2.76	3.00	7.56	2.74	2.76	7.29	2.82	2.58	7.11	2.89	2.46	3.89	3.27	1.19
7	8.43	2.66	3.17	7.80	2.50	3.12	7.47	2.59	2.88	7.24	2.66	2.72	4.08	3.00	1.36
10	8.28	2.42	3.42	8.20	2.48	3.31	7.78	2.61	2.98	7.50	2.72	2.76	5.59	2.65	2.11
12	8.38	2.33	3.60	8.29	2.41	3.44	7.89	2.52	3.13	7.62	2.60	2.93	5.67	2.52	2.25
14	8.39	2.26	3.72	8.30	2.36	3.52	7.91	2.45	3.23	7.64	2.52	3.03	5.69	2.43	2.34
15	8.41	2.23	3.77	8.32	2.34	3.55	7.93	2.43	3.27	7.68	2.49	3.09	5.71	2.39	2.39
19	8.51	2.06	4.13	8.41	2.16	3.89	8.06	2.25	3.59	7.82	2.31	3.39	5.79	2.25	2.58
20	8.53	2.02	4.22	8.43	2.12	3.97	8.09	2.21	3.66	7.86	2.27	3.46	/	/	/
25	8.61	1.87	4.61	8.09	1.90	4.25	7.71	1.96	3.93	7.46	2.01	3.72	/	/	/
30	8.68	1.74	4.99	7.84	1.73	4.53	7.38	1.76	4.20	7.07	1.78	3.98	/	/	/
35	9.03	1.73	5.21	8.16	1.80	4.72	/	/	/	/	/	/	/	/	/
40	9.48	1.74	5.46	/	/	/	/	/	/	/	/	/	/	/	/
43	9.77	1.61	6.08	/	/	/	/	/	/	/	/	/	/	/	/

Abbreviations:

LWT: Leaving water temperature (°C)

DB: Dry-bulb temperature for Outdoor air temperature (°C)

HC: Total heating capacity (kW)

PI: Power input (kW)

Table 2-4.2-2: Heating capacity for 8kW models

Normal															
DB	LWT														
	25			30			35			40			45		
	HC	PI	COP	HC	PI	COP	HC	PI	COP	HC	PI	COP	HC	PI	COP
-25	4.11	1.79	2.29	3.68	1.82	2.03	3.27	1.96	1.67	3.10	1.99	1.56	2.64	2.05	1.29
-20	5.20	1.79	2.90	4.63	1.90	2.43	4.27	1.97	2.17	3.96	2.20	1.80	3.43	2.11	1.62
-15	6.24	1.79	3.49	5.80	1.95	2.98	5.45	2.15	2.53	5.04	2.18	2.32	4.69	2.31	2.03
-10	6.66	1.71	3.89	6.48	1.86	3.49	6.25	1.92	3.26	6.16	2.30	2.68	6.14	2.46	2.50
-7	7.27	1.83	3.97	7.11	2.01	3.53	7.00	2.19	3.20	6.71	2.40	2.79	6.60	2.59	2.55
-5	7.25	1.71	4.25	7.21	1.89	3.81	6.99	2.12	3.30	6.86	2.28	3.01	6.79	2.47	2.75
-2	7.59	1.77	4.28	7.62	1.92	3.97	7.45	2.12	3.51	7.40	2.39	3.10	7.20	2.54	2.84
0	7.60	1.55	4.89	7.78	1.79	4.34	7.67	1.98	3.88	7.74	2.30	3.37	7.16	2.35	3.05
2	7.77	1.45	5.36	7.85	1.69	4.64	7.10	1.73	4.10	7.80	2.21	3.54	7.40	2.28	3.25
5	8.09	1.31	6.17	8.08	1.58	5.13	8.08	1.71	4.73	8.03	2.04	3.93	7.62	2.15	3.54
7	8.60	1.26	6.84	8.21	1.47	5.57	8.40	1.63	5.15	8.00	1.84	4.34	8.10	2.10	3.85
10	9.05	1.14	7.93	8.12	1.33	6.12	7.89	1.41	5.58	7.77	1.74	4.48	7.91	2.00	3.95
12	9.03	1.03	8.78	8.25	1.20	6.87	8.03	1.34	5.99	8.02	1.61	4.98	8.06	1.89	4.26
14	8.98	0.97	9.26	8.26	1.13	7.30	8.05	1.29	6.23	8.09	1.54	5.26	8.09	1.82	4.44
15	8.96	0.93	9.59	8.32	1.09	7.60	8.11	1.27	6.37	8.20	1.50	5.46	8.15	1.79	4.55
19	8.85	0.82	10.83	8.43	0.97	8.72	8.32	1.14	7.30	8.85	0.82	10.83	8.32	1.63	5.11
20	8.82	0.79	11.14	8.46	0.94	9.00	8.37	1.11	7.53	8.58	1.35	6.37	8.36	1.59	5.25
25	8.39	0.73	11.55	8.17	0.86	9.52	8.01	0.98	8.18	8.47	1.23	6.86	8.44	1.38	6.11
30	8.23	0.67	12.29	7.75	0.77	10.04	7.52	0.90	8.39	8.24	1.11	7.46	8.42	1.27	6.61
35	8.63	0.68	12.68	8.13	0.78	10.43	7.89	0.90	8.74	8.64	1.12	7.74	8.83	1.30	6.77
40	9.20	0.70	13.06	8.39	0.75	11.13	8.04	0.87	9.28	8.81	1.09	8.08	9.01	1.30	6.95
43	9.56	0.69	13.92	8.72	0.69	12.61	8.36	0.83	10.03	9.16	1.05	8.74	9.36	1.26	7.40
DB	LWT														
	50			55			58			60			65		
	HC	PI	COP	HC	PI	COP	HC	PI	COP	HC	PI	COP	HC	PI	COP
-25	/	/	/	/	/	/	/	/	/	/	/	/	/	/	/
-20	2.96	2.08	1.42	2.52	2.00	1.25	2.25	1.95	1.15	/	/	/	/	/	/
-15	4.16	2.36	1.76	4.55	2.65	1.72	4.05	2.64	1.53	3.72	2.64	1.41	/	/	/
-10	5.75	2.58	2.23	5.53	2.75	2.01	5.08	2.69	1.89	4.78	2.65	1.81	/	/	/
-7	6.17	2.67	2.31	6.15	3.00	2.05	5.50	2.82	1.95	5.07	2.69	1.89	/	/	/
-5	6.59	2.61	2.52	6.06	2.72	2.23	5.71	2.70	2.12	5.48	2.69	2.04	/	/	/
-2	7.28	2.78	2.61	6.32	2.77	2.29	6.14	2.84	2.16	6.01	2.89	2.08	/	/	/
0	7.39	2.64	2.79	6.33	2.63	2.41	6.15	2.72	2.26	6.03	2.78	2.17	/	/	/
2	7.37	2.53	2.91	7.10	2.73	2.60	6.54	2.73	2.39	6.16	2.74	2.25	/	/	/
5	7.50	2.43	3.09	6.68	2.37	2.82	6.40	2.44	2.62	6.21	2.50	2.49	3.32	2.72	1.22
7	7.53	2.29	3.29	7.50	2.36	3.18	6.75	2.30	2.94	6.25	2.25	2.77	3.44	2.46	1.40
10	7.65	2.18	3.51	7.14	2.11	3.38	6.99	2.30	3.04	6.89	2.45	2.81	4.92	2.27	2.16
12	7.78	2.08	3.74	7.26	2.05	3.54	7.13	2.21	3.22	7.04	2.34	3.01	5.08	2.19	2.32
14	7.80	2.01	3.88	7.28	2.00	3.64	7.15	2.15	3.33	7.07	2.26	3.12	5.12	2.13	2.41
15	7.85	1.98	3.96	7.33	1.99	3.68	7.21	2.13	3.39	7.13	2.24	3.19	5.19	2.11	2.46
19	7.98	1.83	4.37	7.44	1.84	4.05	7.36	2.00	3.67	7.30	2.14	3.42	5.48	2.05	2.67
20	8.01	1.79	4.47	7.47	1.80	4.14	7.39	1.98	3.74	7.34	2.11	3.47	/	/	/
25	8.23	1.68	4.91	7.31	1.64	4.47	7.19	1.78	4.05	7.10	1.89	3.76	/	/	/
30	8.35	1.56	5.36	7.13	1.49	4.80	6.91	1.59	4.35	6.77	1.67	4.06	/	/	/
35	8.75	1.55	5.63	7.48	1.49	5.03	/	/	/	/	/	/	/	/	/
40	8.94	1.50	5.95	/	/	/	/	/	/	/	/	/	/	/	/
43	9.28	1.39	6.67	/	/	/	/	/	/	/	/	/	/	/	/

Abbreviations:

LWT: Leaving water temperature (°C)

DB: Dry-bulb temperature for Outdoor air temperature (°C)

HC: Total heating capacity (kW)

PI: Power input (kW)

Table 2-4.2-3: Heating capacity for 8kW models

Minimum															
DB	LWT														
	25			30			35			40			45		
	HC	PI	COP	HC	PI	COP	HC	PI	COP	HC	PI	COP	HC	PI	COP
-25	2.67	1.15	2.33	2.48	1.21	2.06	2.48	1.46	1.69	2.37	1.50	1.58	1.77	1.37	1.29
-20	3.18	1.08	2.96	2.75	1.11	2.48	2.75	1.24	2.22	2.76	1.51	1.83	2.29	1.40	1.64
-15	3.22	0.90	3.58	3.12	1.03	3.05	2.91	1.12	2.59	3.12	1.31	2.37	3.38	1.64	2.06
-10	2.96	0.74	4.01	2.84	0.79	3.59	2.80	0.84	3.35	3.57	1.30	2.76	4.10	1.61	2.55
-7	1.83	0.45	4.09	1.72	0.47	3.63	1.82	0.53	3.44	3.12	1.07	2.90	3.41	1.28	2.67
-5	2.19	0.50	4.37	2.09	0.53	3.94	2.17	0.63	3.44	3.23	1.03	3.15	3.60	1.27	2.84
-2	5.26	1.15	4.59	5.20	1.24	4.18	5.16	1.41	3.66	5.72	1.76	3.24	5.87	2.02	2.91
0	2.21	0.44	5.06	2.44	0.54	4.49	2.37	0.59	4.01	3.62	1.04	3.48	3.57	1.14	3.12
2	2.54	0.45	5.62	2.75	0.57	4.86	2.69	0.62	4.37	3.80	1.05	3.63	3.80	1.15	3.31
5	2.90	0.45	6.41	3.10	0.58	5.32	3.06	0.62	4.91	4.05	0.99	4.08	4.09	1.12	3.64
7	3.40	0.48	7.14	3.46	0.60	5.81	3.36	0.61	5.54	4.17	0.92	4.53	4.85	1.17	4.15
10	3.08	0.37	8.30	2.72	0.42	6.41	2.83	0.48	5.85	3.92	0.83	4.70	4.73	1.15	4.11
12	3.49	0.38	9.23	3.22	0.45	7.23	3.21	0.51	6.30	4.08	0.78	5.24	4.86	1.09	4.44
14	3.67	0.38	9.75	3.45	0.45	7.69	3.37	0.51	6.57	4.13	0.74	5.55	4.88	1.05	4.64
15	3.86	0.38	10.12	3.69	0.46	8.03	3.55	0.53	6.73	4.20	0.73	5.76	4.94	1.04	4.77
19	4.25	0.37	11.44	4.46	0.48	9.22	4.67	0.60	7.73	4.25	0.37	11.44	5.49	1.02	5.36
20	4.34	0.37	11.77	4.66	0.49	9.52	4.94	0.62	7.98	5.95	0.88	6.74	5.63	1.02	5.51
25	5.18	0.42	12.21	5.31	0.53	10.07	5.51	0.64	8.66	6.68	0.92	7.26	6.48	1.01	6.42
30	5.28	0.41	12.99	5.22	0.49	10.63	5.35	0.60	8.88	6.06	0.77	7.89	6.56	0.94	6.95
35	6.40	0.48	13.42	6.00	0.54	11.04	5.58	0.60	9.26	6.35	0.77	8.20	6.87	0.96	7.12
40	6.82	0.49	13.82	6.21	0.53	11.79	6.34	0.64	9.84	6.96	0.81	8.56	7.41	1.01	7.31
43	7.13	0.48	14.73	6.49	0.49	13.35	6.62	0.62	10.63	7.27	0.78	9.26	7.83	1.01	7.78
DB	LWT														
	50			55			58			60			65		
	HC	PI	COP	HC	PI	COP	HC	PI	COP	HC	PI	COP	HC	PI	COP
-25	/	/	/	/	/	/	/	/	/	/	/	/	/	/	/
-20	2.19	1.52	1.44	1.91	1.51	1.27	1.74	1.49	1.17	/	/	/	/	/	/
-15	3.22	1.80	1.79	3.36	1.92	1.75	3.04	1.96	1.56	2.84	1.99	1.43	/	/	/
-10	4.29	1.88	2.28	4.20	2.05	2.05	3.91	2.03	1.93	3.72	2.02	1.84	/	/	/
-7	3.38	1.44	2.35	3.57	1.67	2.13	3.48	1.73	2.01	3.42	1.78	1.92	/	/	/
-5	3.78	1.46	2.59	3.65	1.59	2.30	3.68	1.69	2.18	3.71	1.77	2.09	/	/	/
-2	5.90	2.20	2.69	5.40	2.23	2.42	5.33	2.37	2.25	5.29	2.47	2.14	/	/	/
0	4.12	1.44	2.86	3.80	1.54	2.47	3.96	1.71	2.32	4.06	1.83	2.22	/	/	/
2	4.26	1.41	3.02	4.01	1.51	2.66	4.13	1.67	2.47	4.21	1.80	2.34	/	/	/
5	4.47	1.41	3.18	4.28	1.47	2.91	4.37	1.62	2.70	4.43	1.73	2.56	2.47	1.99	1.24
7	5.23	1.54	3.40	4.95	1.49	3.33	4.84	1.59	3.05	4.76	1.66	2.87	2.69	1.89	1.42
10	4.99	1.37	3.65	5.17	1.47	3.51	5.08	1.61	3.16	5.02	1.72	2.92	3.80	1.72	2.22
12	5.12	1.31	3.91	5.61	1.52	3.69	5.45	1.64	3.33	5.35	1.74	3.08	3.84	1.62	2.37
14	5.14	1.27	4.06	5.78	1.52	3.80	5.59	1.63	3.43	5.46	1.72	3.18	3.82	1.55	2.47
15	5.19	1.25	4.15	5.99	1.55	3.86	5.76	1.66	3.48	5.60	1.74	3.23	3.82	1.52	2.52
19	5.47	1.19	4.58	5.72	1.34	4.25	5.49	1.43	3.84	5.33	1.49	3.57	3.85	1.40	2.74
20	5.55	1.18	4.69	5.65	1.30	4.35	5.42	1.38	3.93	5.26	1.44	3.65	/	/	/
25	6.46	1.25	5.16	5.81	1.24	4.69	5.59	1.31	4.25	5.45	1.38	3.96	/	/	/
30	6.73	1.20	5.63	5.83	1.16	5.04	5.53	1.21	4.58	5.34	1.25	4.27	/	/	/
35	7.22	1.22	5.92	6.36	1.20	5.29	/	/	/	/	/	/	/	/	/
40	7.68	1.23	6.25	/	/	/	/	/	/	/	/	/	/	/	/
43	8.11	1.16	7.01	/	/	/	/	/	/	/	/	/	/	/	/

Abbreviations:

LWT: Leaving water temperature (°C)

DB: Dry-bulb temperature for Outdoor air temperature (°C)

HC: Total heating capacity (kW)

PI: Power input (kW)

Table 2-4.3-1: Heating capacity for 10kW models

Maximum															
DB	LWT														
	25			30			35			40			45		
	HC	PI	COP	HC	PI	COP	HC	PI	COP	HC	PI	COP	HC	PI	COP
-25	4.68	2.06	2.27	4.21	2.12	1.98	3.78	2.28	1.66	3.52	2.24	1.57	2.96	2.26	1.31
-20	5.98	2.12	2.82	5.35	2.24	2.39	4.98	2.34	2.13	4.55	2.55	1.79	3.89	2.39	1.63
-15	7.26	2.15	3.37	6.78	2.34	2.90	6.43	2.62	2.46	5.86	2.57	2.28	5.57	2.76	2.02
-10	8.37	2.33	3.60	8.14	2.53	3.22	7.89	2.65	2.98	7.64	2.86	2.67	7.38	3.10	2.38
-7	8.72	2.29	3.81	8.48	2.49	3.41	8.31	2.77	3.00	7.96	2.81	2.83	7.68	3.05	2.52
-5	9.00	2.19	4.10	8.86	2.47	3.60	8.80	2.64	3.33	8.46	2.94	2.88	8.18	3.09	2.65
-2	5.59	1.29	4.34	5.47	1.44	3.81	5.59	1.58	3.53	6.22	2.01	3.09	6.24	2.28	2.74
0	9.43	1.93	4.90	9.36	2.31	4.05	9.46	2.52	3.76	9.25	2.93	3.16	8.89	3.10	2.87
2	9.72	1.88	5.18	9.57	2.21	4.34	9.72	2.48	3.93	9.58	2.86	3.35	9.24	3.07	3.01
5	10.24	1.79	5.72	10.07	2.10	4.80	10.13	2.25	4.51	10.10	2.64	3.83	9.79	2.88	3.40
7	10.49	1.77	5.94	10.28	1.97	5.21	10.32	2.09	4.93	10.45	2.50	4.18	10.28	2.76	3.72
10	11.20	1.59	7.04	10.41	1.85	5.64	10.03	1.96	5.13	9.94	2.38	4.17	9.87	2.69	3.67
12	11.36	1.50	7.58	10.56	1.74	6.08	10.17	1.84	5.53	10.08	2.24	4.49	10.01	2.53	3.95
14	11.38	1.44	7.90	10.59	1.67	6.33	10.20	1.77	5.76	10.10	2.16	4.68	10.04	2.44	4.12
15	11.42	1.41	8.10	10.62	1.64	6.49	10.23	1.73	5.90	10.13	2.11	4.80	10.07	2.39	4.22
19	10.93	1.23	8.86	10.73	1.40	7.67	10.58	1.61	6.56	10.57	1.93	5.49	10.24	2.16	4.73
20	10.81	1.19	9.05	10.76	1.35	7.96	10.67	1.59	6.72	10.68	1.89	5.66	10.28	2.12	4.86
25	9.94	1.04	9.59	9.90	1.17	8.44	9.82	1.38	7.12	9.82	1.64	6.00	9.46	1.84	5.15
30	9.77	0.96	10.15	9.07	1.03	8.79	8.90	1.12	7.95	8.85	1.32	6.72	9.92	1.61	6.15
35	10.16	0.95	10.73	9.44	1.03	9.15	9.25	1.11	8.30	9.21	1.32	6.97	10.32	1.61	6.40
40	10.67	0.93	11.52	9.91	1.01	9.81	9.71	1.15	8.47	9.67	1.32	7.34	10.84	1.60	6.79
43	10.99	0.91	12.03	10.20	0.96	10.61	10.00	1.08	9.25	9.96	1.23	8.07	11.16	1.47	7.58
DB	LWT														
	50			55			58			60			65		
	HC	PI	COP	HC	PI	COP	HC	PI	COP	HC	PI	COP	HC	PI	COP
-25	/	/	/	/	/	/	/	/	/	/	/	/	/	/	/
-20	3.34	2.35	1.42	2.75	2.18	1.26	2.40	2.06	1.16	/	/	/	/	/	/
-15	5.22	2.99	1.74	5.20	3.04	1.71	4.60	3.00	1.54	4.20	2.96	1.42	/	/	/
-10	7.03	3.31	2.13	6.67	3.58	1.86	5.90	3.33	1.77	5.38	3.15	1.71	/	/	/
-7	7.33	3.26	2.25	7.05	3.53	1.97	6.18	3.30	1.87	5.61	3.10	1.81	/	/	/
-5	8.04	3.27	2.46	7.53	3.32	2.27	6.69	3.19	2.09	6.13	3.10	1.98	/	/	/
-2	6.24	2.48	2.52	6.02	2.67	2.26	5.57	2.66	2.10	5.27	2.65	1.99	/	/	/
0	8.82	3.27	2.70	8.18	3.31	2.47	7.46	3.31	2.26	6.99	3.30	2.12	/	/	/
2	9.02	3.22	2.80	8.51	3.38	2.52	7.80	3.36	2.32	7.32	3.34	2.19	/	/	/
5	9.45	3.14	3.01	9.08	3.27	2.78	8.34	3.23	2.58	7.85	3.20	2.45	4.52	3.30	1.37
7	9.83	3.05	3.22	9.72	3.20	3.04	8.82	3.06	2.88	8.23	2.96	2.78	4.85	3.11	1.56
10	9.59	2.91	3.30	9.57	3.11	3.08	8.79	3.07	2.86	8.27	3.04	2.72	6.44	3.05	2.11
12	9.72	2.74	3.55	9.71	2.93	3.32	8.92	2.89	3.08	8.39	2.86	2.93	6.53	2.87	2.27
14	9.75	2.63	3.70	9.73	2.81	3.46	8.94	2.78	3.21	8.40	2.75	3.05	6.54	2.76	2.37
15	9.78	2.58	3.80	9.76	2.76	3.54	8.97	2.72	3.29	8.43	2.70	3.13	6.56	2.71	2.43
19	9.97	2.42	4.13	9.83	2.58	3.81	9.22	2.58	3.57	8.80	2.58	3.41	6.65	2.50	2.66
20	10.02	2.38	4.21	9.85	2.54	3.88	9.28	2.55	3.64	8.90	2.56	3.48	/	/	/
25	9.22	2.07	4.46	9.06	2.20	4.11	8.54	2.21	3.86	8.18	2.22	3.69	/	/	/
30	9.31	1.88	4.96	9.04	1.88	4.80	8.11	1.92	4.22	7.49	1.96	3.83	/	/	/
35	9.69	1.87	5.17	9.42	1.90	4.96	/	/	/	/	/	/	/	/	/
40	10.17	1.84	5.53	/	/	/	/	/	/	/	/	/	/	/	/
43	10.48	1.68	6.25	/	/	/	/	/	/	/	/	/	/	/	/

Abbreviations:

LWT: Leaving water temperature (°C)

DB: Dry-bulb temperature for Outdoor air temperature (°C)

HC: Total heating capacity (kW)

PI: Power input (kW)

Table 2-4.3-2: Heating capacity for 10kW models

Normal															
DB	LWT														
	25			30			35			40			45		
	HC	PI	COP	HC	PI	COP	HC	PI	COP	HC	PI	COP	HC	PI	COP
-25	4.33	1.87	2.32	3.87	1.89	2.05	3.45	2.05	1.68	3.26	2.07	1.57	2.78	2.14	1.30
-20	5.47	1.87	2.93	4.87	1.98	2.46	4.50	2.05	2.20	4.17	2.29	1.82	3.61	2.20	1.64
-15	6.57	1.86	3.53	6.10	2.03	3.01	5.73	2.24	2.56	5.31	2.27	2.34	4.94	2.41	2.05
-10	7.49	1.97	3.81	7.25	2.15	3.37	6.95	2.26	3.08	6.84	2.50	2.74	6.69	2.78	2.41
-7	8.28	2.11	3.92	8.18	2.33	3.51	8.00	2.62	3.05	7.43	2.54	2.93	7.35	2.88	2.55
-5	8.13	1.89	4.29	8.21	2.22	3.70	8.16	2.39	3.41	7.56	2.55	2.96	7.43	2.73	2.72
-2	8.40	1.91	4.40	8.28	2.16	3.84	8.31	2.33	3.56	8.13	2.70	3.01	7.91	2.85	2.78
0	8.33	1.64	5.06	8.25	1.99	4.15	8.33	2.16	3.86	8.23	2.57	3.20	7.87	2.65	2.97
2	8.62	1.61	5.34	8.68	1.92	4.52	8.20	2.05	4.00	8.79	2.54	3.46	7.85	2.45	3.20
5	9.09	1.53	5.95	9.00	1.81	4.99	9.07	1.94	4.68	9.23	2.35	3.92	8.58	2.41	3.55
7	10.22	1.69	6.05	9.98	1.85	5.40	10.00	2.02	4.95	10.14	2.36	4.29	10.00	2.67	3.75
10	10.06	1.34	7.50	9.12	1.54	5.91	8.85	1.68	5.28	8.88	2.04	4.35	8.94	2.40	3.72
12	10.26	1.25	8.19	9.29	1.44	6.45	9.03	1.57	5.77	9.05	1.91	4.74	9.11	2.25	4.06
14	10.30	1.20	8.58	9.33	1.38	6.76	9.06	1.50	6.04	9.08	1.83	4.97	9.14	2.15	4.25
15	10.38	1.18	8.83	9.40	1.35	6.96	9.13	1.47	6.22	9.16	1.79	5.12	9.22	2.10	4.38
19	9.98	1.03	9.72	9.54	1.15	8.27	9.49	1.36	6.96	9.59	1.63	5.89	9.41	1.90	4.94
20	9.88	0.99	9.94	9.58	1.11	8.60	9.58	1.34	7.14	9.70	1.60	6.08	9.46	1.86	5.08
25	8.86	0.83	10.61	8.98	0.98	9.18	8.99	1.18	7.63	9.10	1.40	6.49	8.87	1.63	5.43
30	8.76	0.77	11.31	8.28	0.86	9.63	8.19	0.96	8.57	8.24	1.13	7.32	9.35	1.43	6.53
35	9.19	0.76	12.03	8.69	0.86	10.10	8.59	0.95	9.01	8.65	1.13	7.65	9.81	1.43	6.84
40	9.79	0.75	13.01	8.97	0.82	10.90	8.75	0.95	9.26	8.82	1.09	8.11	10.01	1.37	7.31
43	10.17	0.74	13.67	9.32	0.79	11.87	9.10	0.89	10.18	9.16	1.02	8.98	10.40	1.27	8.21
DB	LWT														
	50			55			58			60			65		
	HC	PI	COP	HC	PI	COP	HC	PI	COP	HC	PI	COP	HC	PI	COP
-25	/	/	/	/	/	/	/	/	/	/	/	/	/	/	/
-20	3.11	2.17	1.44	2.65	2.09	1.27	2.37	2.03	1.17	/	/	/	/	/	/
-15	4.78	2.68	1.78	4.69	2.70	1.74	4.23	2.73	1.55	3.91	2.75	1.42	/	/	/
-10	6.41	2.96	2.16	6.08	3.23	1.88	5.41	3.05	1.78	4.96	2.91	1.70	/	/	/
-7	7.00	3.04	2.30	6.85	3.43	2.00	5.82	3.06	1.91	5.14	2.79	1.84	/	/	/
-5	7.08	2.81	2.52	6.89	2.98	2.31	6.03	2.83	2.13	5.46	2.71	2.02	/	/	/
-2	7.94	3.07	2.59	7.34	3.07	2.39	6.61	3.03	2.18	6.12	3.01	2.04	/	/	/
0	8.03	2.92	2.75	7.30	2.87	2.54	6.61	2.89	2.28	6.16	2.91	2.11	/	/	/
2	8.20	2.84	2.89	8.10	3.16	2.56	7.40	3.14	2.36	6.94	3.12	2.23	/	/	/
5	8.53	2.76	3.09	8.02	2.82	2.84	7.32	2.79	2.62	6.86	2.77	2.48	3.86	2.75	1.40
7	9.58	2.92	3.28	9.50	3.07	3.10	8.42	2.86	2.94	7.70	2.72	2.83	4.29	2.66	1.61
10	8.86	2.62	3.39	8.34	2.65	3.14	7.89	2.70	2.92	7.60	2.74	2.77	5.66	2.62	2.16
12	9.03	2.44	3.69	8.50	2.49	3.41	8.05	2.54	3.17	7.75	2.57	3.01	5.84	2.50	2.34
14	9.06	2.34	3.87	8.53	2.39	3.57	8.08	2.44	3.32	7.77	2.47	3.15	5.89	2.42	2.44
15	9.14	2.29	3.99	8.60	2.34	3.67	8.14	2.39	3.41	7.84	2.42	3.23	5.97	2.39	2.50
19	9.36	2.14	4.36	8.70	2.19	3.97	8.41	2.30	3.65	8.21	2.39	3.44	6.29	2.28	2.76
20	9.41	2.11	4.46	8.73	2.16	4.05	8.48	2.28	3.71	8.31	2.38	3.49	/	/	/
25	8.82	1.85	4.76	8.19	1.89	4.32	7.95	2.00	3.97	7.79	2.09	3.73	/	/	/
30	8.96	1.68	5.33	8.21	1.61	5.08	7.58	1.73	4.37	7.17	1.84	3.90	/	/	/
35	9.39	1.68	5.59	8.63	1.63	5.29	/	/	/	/	/	/	/	/	/
40	9.59	1.59	6.02	/	/	/	/	/	/	/	/	/	/	/	/
43	9.96	1.45	6.85	/	/	/	/	/	/	/	/	/	/	/	/

Abbreviations:

LWT: Leaving water temperature (°C)

DB: Dry-bulb temperature for Outdoor air temperature (°C)

HC: Total heating capacity (kW)

PI: Power input (kW)

Table 2-4.3-3: Heating capacity for 10kW models

Minimum																
DB	LWT															
	25			30			35			40			45			
	HC	PI	COP	HC	PI	COP	HC	PI	COP	HC	PI	COP	HC	PI	COP	
-25	2.81	1.19	2.35	2.61	1.26	2.08	2.61	1.53	1.71	2.50	1.56	1.60	1.87	1.43	1.31	
-20	3.35	1.12	2.99	2.89	1.15	2.50	2.89	1.29	2.24	2.91	1.57	1.85	2.41	1.46	1.66	
-15	3.39	0.94	3.61	3.29	1.07	3.08	3.06	1.17	2.62	3.28	1.37	2.40	3.56	1.71	2.08	
-10	3.32	0.85	3.91	3.18	0.92	3.47	3.11	0.98	3.17	3.97	1.41	2.82	4.47	1.82	2.46	
-7	2.09	0.51	4.14	1.95	0.54	3.64	2.05	0.61	3.37	3.52	1.14	3.08	3.77	1.41	2.67	
-5	2.39	0.53	4.48	2.32	0.60	3.84	2.48	0.70	3.57	3.67	1.17	3.13	3.95	1.41	2.80	
-2	5.87	1.27	4.64	5.75	1.42	4.05	5.92	1.59	3.73	6.45	2.01	3.21	6.51	2.26	2.87	
0	2.42	0.46	5.24	2.68	0.62	4.30	2.67	0.67	3.99	3.99	1.20	3.31	3.92	1.29	3.04	
2	2.82	0.50	5.60	3.04	0.65	4.69	3.03	0.70	4.34	4.29	1.18	3.62	4.23	1.29	3.28	
5	3.26	0.53	6.18	3.45	0.67	5.18	3.43	0.71	4.86	4.65	1.14	4.07	4.61	1.26	3.66	
7	3.76	0.58	6.48	3.86	0.68	5.69	3.81	0.71	5.39	4.92	1.09	4.53	5.55	1.36	4.09	
10	3.43	0.44	7.86	3.05	0.49	6.19	3.17	0.57	5.54	4.47	0.98	4.55	5.34	1.38	3.86	
12	3.98	0.46	8.60	3.63	0.54	6.78	3.61	0.59	6.07	4.61	0.92	4.99	5.49	1.30	4.24	
14	4.21	0.47	9.03	3.89	0.55	7.12	3.79	0.59	6.38	4.64	0.89	5.24	5.52	1.24	4.45	
15	4.48	0.48	9.32	4.17	0.57	7.35	4.00	0.61	6.58	4.69	0.87	5.40	5.58	1.21	4.59	
19	4.79	0.47	10.27	5.05	0.58	8.75	5.33	0.72	7.36	6.32	1.01	6.23	6.22	1.20	5.19	
20	4.86	0.46	10.51	5.27	0.58	9.10	5.66	0.75	7.56	6.73	1.05	6.44	6.38	1.19	5.34	
25	5.47	0.49	11.22	5.84	0.60	9.72	6.19	0.77	8.07	7.17	1.04	6.87	6.81	1.19	5.70	
30	5.62	0.47	11.96	5.58	0.55	10.20	5.83	0.64	9.08	6.06	0.78	7.75	7.29	1.06	6.86	
35	6.81	0.53	12.73	6.42	0.60	10.69	6.07	0.64	9.55	6.35	0.78	8.10	7.64	1.06	7.19	
40	7.26	0.53	13.76	6.64	0.58	11.54	6.90	0.70	9.81	6.96	0.81	8.59	8.24	1.07	7.68	
43	7.59	0.52	14.47	6.94	0.55	12.57	7.20	0.67	10.79	7.27	0.76	9.51	8.71	1.01	8.64	
DB	LWT															
	50			55			58			60			65			
	HC	PI	COP	HC	PI	COP	HC	PI	COP	HC	PI	COP	HC	PI	COP	
-25	/	/	/	/	/	/	/	/	/	/	/	/	/	/	/	
-20	2.31	1.59	1.45	2.01	1.57	1.28	1.83	1.56	1.18	/	/	/	/	/	/	
-15	3.39	1.88	1.81	3.53	2.00	1.76	3.20	2.04	1.57	2.98	2.07	1.44	/	/	/	
-10	4.78	2.17	2.20	4.62	2.40	1.92	4.17	2.30	1.81	3.87	2.22	1.74	/	/	/	
-7	3.82	1.62	2.36	3.99	1.93	2.07	3.76	1.92	1.96	3.60	1.91	1.88	/	/	/	
-5	4.13	1.60	2.58	4.26	1.79	2.38	3.96	1.81	2.19	3.76	1.83	2.06	/	/	/	
-2	6.49	2.43	2.68	6.32	2.59	2.44	5.84	2.60	2.24	5.52	2.61	2.11	/	/	/	
0	4.48	1.59	2.82	4.38	1.68	2.61	4.24	1.81	2.34	4.14	1.91	2.17	/	/	/	
2	4.74	1.58	3.00	4.72	1.74	2.71	4.58	1.85	2.47	4.48	1.94	2.31	/	/	/	
5	5.08	1.60	3.18	5.14	1.76	2.92	4.99	1.85	2.70	4.89	1.92	2.55	2.87	2.02	1.42	
7	6.10	1.76	3.46	6.17	1.90	3.25	5.72	1.87	3.06	5.41	1.85	2.93	3.19	1.96	1.63	
10	5.78	1.64	3.52	6.04	1.85	3.27	5.74	1.89	3.04	5.54	1.92	2.88	4.38	1.98	2.22	
12	5.94	1.54	3.86	6.57	1.84	3.56	6.16	1.88	3.28	5.88	1.91	3.08	4.41	1.84	2.39	
14	5.97	1.47	4.05	6.78	1.82	3.74	6.31	1.85	3.42	6.00	1.87	3.20	4.39	1.76	2.50	
15	6.03	1.44	4.18	7.03	1.83	3.85	6.51	1.86	3.50	6.16	1.88	3.27	4.40	1.71	2.56	
19	6.42	1.40	4.58	6.69	1.60	4.17	6.27	1.64	3.83	6.00	1.67	3.59	4.42	1.56	2.83	
20	6.51	1.39	4.68	6.60	1.55	4.25	6.22	1.59	3.91	5.96	1.62	3.67	/	/	/	
25	6.92	1.38	5.00	6.51	1.43	4.54	6.19	1.48	4.17	5.97	1.52	3.93	/	/	/	
30	7.22	1.29	5.59	6.71	1.26	5.34	6.08	1.32	4.60	5.65	1.38	4.11	/	/	/	
35	7.75	1.32	5.88	7.34	1.32	5.56	/	/	/	/	/	/	/	/	/	
40	8.24	1.30	6.33	/	/	/	/	/	/	/	/	/	/	/	/	
43	8.70	1.21	7.20	/	/	/	/	/	/	/	/	/	/	/	/	

Abbreviations:

LWT: Leaving water temperature (°C)

DB: Dry-bulb temperature for Outdoor air temperature (°C)

HC: Total heating capacity (kW)

PI: Power input (kW)

Table 2-4.4-1: Heating capacity for 12kW models

Maximum															
DB	LWT														
	25			30			35			40			45		
	HC	PI	COP	HC	PI	COP	HC	PI	COP	HC	PI	COP	HC	PI	COP
-25	6.33	2.92	2.17	5.96	2.77	2.15	5.03	2.96	1.70	4.53	3.12	1.45	4.23	3.29	1.28
-20	7.75	3.04	2.55	7.49	3.00	2.50	7.21	3.34	2.16	6.38	3.41	1.87	6.05	3.52	1.72
-15	8.95	3.13	2.85	8.66	3.27	2.65	8.36	3.41	2.45	7.93	3.62	2.19	7.39	3.95	1.87
-10	10.98	3.47	3.17	10.38	3.79	2.74	10.02	3.95	2.54	9.69	4.34	2.23	9.32	4.54	2.05
-7	12.30	3.52	3.49	10.94	3.62	3.02	11.02	3.89	2.83	10.42	4.27	2.44	10.40	4.50	2.31
-5	12.35	3.33	3.71	11.21	3.55	3.15	11.30	3.87	2.92	10.94	4.26	2.57	10.94	4.61	2.37
-2	12.04	3.11	3.87	11.28	3.28	3.44	11.30	3.56	3.17	11.29	4.07	2.77	11.46	4.46	2.57
0	12.48	2.87	4.35	12.09	3.18	3.80	11.99	3.44	3.48	12.25	4.04	3.04	12.29	4.37	2.81
2	13.36	2.80	4.78	12.73	3.11	4.09	12.64	3.45	3.66	12.87	3.93	3.28	12.83	4.40	2.92
5	14.60	2.66	5.49	13.71	3.02	4.55	13.62	3.28	4.15	13.78	3.70	3.73	13.62	4.18	3.26
7	15.45	2.57	6.00	14.67	2.93	5.01	14.57	3.11	4.69	14.80	3.57	4.14	14.51	4.00	3.63
10	14.95	2.40	6.22	14.36	2.62	5.49	14.30	2.83	5.06	14.61	3.34	4.37	14.32	3.89	3.69
12	15.10	2.17	6.96	14.59	2.40	6.08	14.39	2.74	5.25	14.84	3.26	4.55	14.52	3.71	3.92
14	15.06	2.07	7.27	14.60	2.31	6.33	14.34	2.70	5.31	14.85	3.22	4.61	14.52	3.63	4.00
15	15.12	1.97	7.67	14.70	2.21	6.65	14.36	2.65	5.43	14.96	3.17	4.72	14.61	3.53	4.14
19	14.67	1.72	8.54	14.39	1.94	7.41	14.25	2.28	6.26	14.86	2.83	5.25	14.72	3.22	4.58
20	14.56	1.66	8.76	14.32	1.88	7.60	14.22	2.20	6.47	14.84	2.75	5.39	14.75	3.15	4.69
25	14.41	1.55	9.31	14.28	1.73	8.23	14.18	1.93	7.35	14.72	2.35	6.26	14.70	2.73	5.39
30	14.64	1.45	10.12	14.20	1.62	8.75	14.35	1.85	7.76	14.69	2.22	6.63	14.73	2.63	5.59
35	15.17	1.39	10.87	14.86	1.60	9.29	14.71	1.80	8.16	15.09	2.17	6.95	14.57	2.50	5.83
40	15.69	1.41	11.10	15.59	1.59	9.82	15.48	1.79	8.65	15.96	2.17	7.36	15.34	2.44	6.29
43	16.15	1.35	11.96	15.95	1.50	10.61	15.89	1.73	9.18	16.48	2.11	7.82	15.99	2.35	6.81
DB	LWT														
	50			55			58			60			65		
	HC	PI	COP	HC	PI	COP	HC	PI	COP	HC	PI	COP	HC	PI	COP
-25	/	/	/	/	/	/	/	/	/	/	/	/	/	/	/
-20	5.36	3.55	1.51	5.08	3.63	1.40	4.90	3.68	1.33	/	/	/	/	/	/
-15	6.71	3.97	1.69	6.33	4.31	1.47	6.05	4.52	1.34	5.87	4.69	1.25	/	/	/
-10	8.96	4.62	1.94	8.60	4.79	1.79	7.46	4.97	1.50	6.70	5.13	1.30	/	/	/
-7	10.61	4.74	2.24	10.59	5.25	2.02	9.06	5.15	1.76	8.05	5.06	1.59	/	/	/
-5	10.77	4.75	2.27	10.55	5.14	2.05	9.15	5.14	1.78	8.21	5.14	1.60	/	/	/
-2	10.82	4.65	2.33	10.56	4.91	2.15	9.22	5.00	1.84	8.33	5.09	1.64	/	/	/
0	11.12	4.61	2.41	10.77	4.74	2.27	9.42	4.89	1.93	8.52	5.03	1.69	/	/	/
2	11.85	4.52	2.62	11.64	4.62	2.52	10.61	4.92	2.15	9.92	5.19	1.91	/	/	/
5	12.81	4.46	2.88	12.82	4.70	2.73	12.07	4.90	2.46	11.57	5.06	2.29	9.92	5.16	1.92
7	13.91	4.43	3.14	13.85	4.66	2.97	13.31	4.89	2.72	12.95	5.07	2.56	11.54	5.17	2.23
10	13.54	4.11	3.30	13.12	4.38	2.99	12.87	4.61	2.79	12.70	4.79	2.65	11.69	4.89	2.39
12	13.54	3.92	3.45	12.64	4.19	3.02	12.58	4.40	2.86	12.55	4.56	2.75	11.76	4.65	2.53
14	13.44	3.84	3.50	12.31	4.09	3.01	12.35	4.30	2.87	12.38	4.45	2.78	11.71	4.55	2.58
15	13.42	3.73	3.60	12.05	3.97	3.03	12.19	4.18	2.92	12.29	4.32	2.85	11.73	4.42	2.65
19	13.61	3.43	3.97	12.03	3.63	3.32	11.45	3.74	3.06	11.07	3.83	2.89	11.82	3.98	2.97
20	13.66	3.37	4.06	12.02	3.55	3.39	11.27	3.64	3.10	10.76	3.71	2.90	/	/	/
25	13.90	3.00	4.63	12.00	3.12	3.84	10.82	3.25	3.33	10.03	3.36	2.99	/	/	/
30	13.95	2.82	4.95	12.64	2.94	4.30	11.26	3.18	3.55	10.34	3.40	3.04	/	/	/
35	14.23	2.72	5.24	12.89	2.79	4.62	/	/	/	/	/	/	/	/	/
40	14.51	2.69	5.40	/	/	/	/	/	/	/	/	/	/	/	/
43	14.78	2.57	5.75	/	/	/	/	/	/	/	/	/	/	/	/

Abbreviations:

LWT: Leaving water temperature (°C)

DB: Dry-bulb temperature for Outdoor air temperature (°C)

HC: Total heating capacity (kW)

PI: Power input (kW)

Table 2-4.4-2: Heating capacity for 12kW models

Normal																
DB	LWT															
	25			30			35			40			45			
	HC	PI	COP	HC	PI	COP	HC	PI	COP	HC	PI	COP	HC	PI	COP	
-25	5.36	2.32	2.30	5.12	2.23	2.29	4.24	2.37	1.79	3.88	2.57	1.51	3.66	2.82	1.30	
-20	6.73	2.45	2.75	6.60	2.44	2.70	6.25	2.72	2.30	5.62	2.85	1.97	5.31	3.01	1.77	
-15	7.43	2.41	3.09	7.35	2.55	2.88	7.28	2.78	2.62	6.63	2.86	2.32	6.04	3.13	1.93	
-10	9.06	2.69	3.37	8.26	2.83	2.92	8.14	3.06	2.66	8.00	3.45	2.32	7.80	3.70	2.11	
-7	11.09	3.11	3.57	10.29	3.26	3.15	10.00	3.33	3.00	10.14	4.06	2.50	10.20	4.25	2.40	
-5	10.26	2.55	4.03	10.22	3.19	3.20	9.95	3.28	3.03	10.07	3.76	2.68	10.18	4.15	2.45	
-2	9.94	2.39	4.16	9.81	2.75	3.57	9.57	2.86	3.35	9.83	3.35	2.94	10.06	3.76	2.68	
0	10.23	2.21	4.63	10.05	2.51	4.01	9.79	2.62	3.74	10.11	3.11	3.25	10.23	3.46	2.96	
2	10.74	2.05	5.23	9.96	2.23	4.47	9.20	2.36	3.90	10.07	2.81	3.58	10.60	3.53	3.00	
5	11.77	1.95	6.05	10.77	2.18	4.94	10.57	2.35	4.50	10.83	2.65	4.08	11.08	3.16	3.51	
7	12.90	1.96	6.57	12.11	2.23	5.42	12.10	2.44	4.95	12.35	2.75	4.50	12.30	3.32	3.70	
10	11.82	1.72	6.88	11.23	1.87	5.99	10.88	1.97	5.51	11.26	2.34	4.81	10.91	2.74	3.99	
12	11.97	1.55	7.73	11.44	1.71	6.67	10.98	1.91	5.75	11.47	2.28	5.04	11.10	2.61	4.26	
14	11.97	1.48	8.10	11.47	1.65	6.96	10.96	1.88	5.83	11.51	2.25	5.11	11.12	2.55	4.36	
15	12.03	1.41	8.56	11.57	1.58	7.32	11.00	1.84	5.97	11.61	2.21	5.24	11.20	2.48	4.52	
19	11.58	1.21	9.60	11.23	1.37	8.22	10.82	1.56	6.93	11.43	1.94	5.88	11.19	2.22	5.03	
20	11.47	1.16	9.86	11.15	1.32	8.45	10.77	1.50	7.18	11.39	1.89	6.04	11.19	2.17	5.16	
25	11.42	1.09	10.47	11.19	1.22	9.15	10.81	1.33	8.15	11.37	1.46	7.79	11.22	1.89	5.93	
30	11.71	1.04	11.31	11.23	1.16	9.66	11.05	1.29	8.55	11.46	1.41	8.15	11.36	1.93	5.88	
35	12.36	1.02	12.09	11.97	1.17	10.21	11.55	1.32	8.78	11.99	1.60	7.49	11.45	1.86	6.17	
40	13.10	1.06	12.42	12.88	1.19	10.86	12.46	1.33	9.37	13.00	1.63	7.99	12.36	1.84	6.71	
43	13.73	1.02	13.47	13.41	1.14	11.81	13.03	1.30	10.01	13.68	1.60	8.54	13.12	1.80	7.31	
DB	LWT															
	50			55			58			60			65			
	HC	PI	COP	HC	PI	COP	HC	PI	COP	HC	PI	COP	HC	PI	COP	
-25	/	/	/	/	/	/	/	/	/	/	/	/	/	/	/	
-20	4.72	3.03	1.56	4.63	3.30	1.40	4.57	3.50	1.31	/	/	/	/	/	/	
-15	5.51	3.14	1.75	5.30	3.58	1.48	5.10	3.82	1.33	4.96	4.01	1.24	/	/	/	
-10	7.54	3.77	2.00	7.24	3.91	1.85	6.32	4.11	1.54	5.70	4.30	1.33	/	/	/	
-7	10.28	4.48	2.29	9.80	4.78	2.05	8.34	4.63	1.80	7.23	4.42	1.64	/	/	/	
-5	10.15	4.37	2.32	9.96	4.72	2.11	8.33	4.57	1.82	7.24	4.44	1.63	/	/	/	
-2	10.02	4.21	2.38	9.85	4.45	2.22	8.29	4.39	1.89	7.26	4.34	1.67	/	/	/	
0	10.13	4.12	2.46	9.94	4.24	2.34	8.37	4.24	1.98	7.33	4.23	1.73	/	/	/	
2	10.13	3.82	2.65	11.30	4.52	2.50	9.46	4.26	2.22	8.17	4.08	2.01	/	/	/	
5	11.75	4.01	2.93	11.60	4.13	2.81	10.17	3.98	2.55	9.21	3.86	2.38	8.19	4.05	2.02	
7	12.17	3.75	3.25	11.90	3.90	3.05	11.29	3.98	2.84	10.81	4.06	2.66	9.64	4.10	2.35	
10	10.10	2.93	3.44	9.86	3.16	3.13	9.90	3.42	2.89	9.92	3.62	2.74	9.48	3.80	2.49	
12	10.13	2.79	3.62	9.53	3.01	3.17	9.71	3.25	2.98	9.83	3.44	2.86	9.56	3.59	2.66	
14	10.07	2.73	3.69	9.30	2.94	3.16	9.55	3.18	3.00	9.71	3.36	2.89	9.54	3.50	2.72	
15	10.08	2.66	3.79	9.12	2.85	3.20	9.44	3.09	3.06	9.66	3.26	2.97	9.57	3.39	2.82	
19	10.13	2.40	4.21	9.02	2.56	3.52	8.79	2.72	3.23	8.63	2.84	3.04	9.72	3.03	3.20	
20	10.14	2.35	4.32	9.00	2.50	3.61	8.62	2.63	3.28	8.37	2.74	3.06	/	/	/	
25	10.39	2.11	4.93	9.04	2.21	4.09	8.33	2.36	3.52	7.85	2.50	3.14	/	/	/	
30	10.53	2.01	5.24	9.62	2.14	4.49	8.75	2.37	3.70	8.17	2.58	3.17	/	/	/	
35	10.95	1.96	5.58	10.00	2.06	4.86	/	/	/	/	/	/	/	/	/	
40	11.46	1.98	5.80	/	/	/	/	/	/	/	/	/	/	/	/	
43	11.90	1.91	6.22	/	/	/	/	/	/	/	/	/	/	/	/	

Abbreviations:

LWT: Leaving water temperature (°C)

DB: Dry-bulb temperature for Outdoor air temperature (°C)

HC: Total heating capacity (kW)

PI: Power input (kW)

Table 2-4.4-3: Heating capacity for 12kW models

Minimum															
DB	LWT														
	25			30			35			40			45		
	HC	PI	COP	HC	PI	COP	HC	PI	COP	HC	PI	COP	HC	PI	COP
-25	3.64	1.54	2.36	3.52	1.50	2.35	3.27	1.81	1.81	3.08	2.01	1.53	2.83	2.17	1.30
-20	4.44	1.60	2.78	4.22	1.54	2.74	4.08	1.75	2.33	3.72	1.86	2.00	3.93	2.25	1.75
-15	4.85	1.54	3.16	5.00	1.70	2.94	4.92	1.83	2.68	4.55	1.92	2.37	4.73	2.45	1.93
-10	4.67	1.34	3.49	4.48	1.48	3.03	4.36	1.59	2.74	4.39	1.84	2.38	4.85	2.25	2.15
-7	4.61	1.17	3.94	3.85	1.15	3.36	3.97	1.26	3.14	4.20	1.53	2.74	5.41	2.14	2.52
-5	4.75	1.13	4.19	4.06	1.15	3.53	4.18	1.28	3.26	4.52	1.56	2.90	5.80	2.23	2.61
-2	4.73	1.08	4.40	4.21	1.09	3.86	4.27	1.20	3.55	4.75	1.51	3.14	6.16	2.18	2.83
0	4.99	1.01	4.96	4.64	1.08	4.28	4.62	1.18	3.92	5.24	1.52	3.45	6.70	2.15	3.11
2	5.41	0.98	5.54	4.95	1.06	4.69	4.92	1.16	4.23	5.56	1.45	3.83	7.04	2.12	3.32
5	5.91	0.93	6.35	5.34	1.03	5.19	5.31	1.12	4.73	5.97	1.39	4.29	7.49	2.05	3.66
7	6.15	0.88	6.98	5.53	0.96	5.79	5.58	1.04	5.38	6.30	1.31	4.80	7.88	1.92	4.10
10	6.10	0.84	7.24	5.72	0.91	6.31	5.62	0.97	5.81	6.37	1.26	5.07	7.92	1.90	4.16
12	6.05	0.75	8.12	5.78	0.82	7.01	5.65	0.94	6.04	6.69	1.26	5.29	8.05	1.81	4.44
14	5.97	0.70	8.49	5.76	0.79	7.30	5.62	0.92	6.11	6.78	1.27	5.36	8.05	1.77	4.54
15	5.93	0.66	8.96	5.78	0.75	7.68	5.62	0.90	6.26	6.92	1.26	5.49	8.09	1.72	4.69
19	5.83	0.58	10.05	5.74	0.67	8.61	5.65	0.78	7.27	6.96	1.13	6.16	8.24	1.58	5.23
20	5.81	0.56	10.32	5.73	0.65	8.85	5.66	0.75	7.52	6.97	1.10	6.32	8.27	1.54	5.36
25	5.89	0.54	10.97	5.85	0.61	9.58	5.79	0.68	8.54	7.06	0.96	7.36	8.39	1.36	6.16
30	6.83	0.58	11.82	6.96	0.69	10.11	7.82	0.89	8.78	8.23	1.09	7.52	8.52	1.38	6.18
35	7.23	0.56	12.79	7.43	0.69	10.81	8.17	0.88	9.31	8.60	1.08	7.94	8.58	1.32	6.49
40	7.63	0.58	13.14	7.95	0.69	11.50	8.75	0.88	9.93	9.09	1.07	8.47	9.05	1.28	7.05
43	8.10	0.57	14.26	8.37	0.67	12.51	9.22	0.87	10.62	9.64	1.06	9.06	9.75	1.27	7.69
DB	LWT														
	50			55			58			60			65		
	HC	PI	COP	HC	PI	COP	HC	PI	COP	HC	PI	COP	HC	PI	COP
-25	/	/	/	/	/	/	/	/	/	/	/	/	/	/	/
-20	3.75	2.43	1.54	3.60	2.58	1.39	3.51	2.69	1.30	/	/	/	/	/	/
-15	4.63	2.64	1.75	4.43	2.98	1.49	4.31	3.21	1.34	4.22	3.39	1.25	/	/	/
-10	5.11	2.50	2.04	5.33	2.83	1.89	4.82	3.08	1.57	4.49	3.32	1.35	/	/	/
-7	5.73	2.41	2.37	6.03	2.79	2.16	5.55	2.96	1.87	5.23	3.11	1.68	/	/	/
-5	5.93	2.44	2.43	6.12	2.79	2.20	5.70	3.01	1.89	5.42	3.20	1.69	/	/	/
-2	5.95	2.35	2.53	6.12	2.66	2.30	5.78	2.95	1.96	5.56	3.20	1.74	/	/	/
0	6.12	2.31	2.65	6.23	2.58	2.42	5.94	2.90	2.05	5.75	3.18	1.81	/	/	/
2	6.66	2.32	2.87	7.10	2.68	2.65	6.89	2.97	2.32	6.76	3.22	2.10	/	/	/
5	7.30	2.32	3.15	8.08	2.71	2.98	7.95	2.97	2.68	7.87	3.18	2.48	6.99	3.33	2.10
7	7.83	2.26	3.46	8.63	2.64	3.27	8.68	2.91	2.98	8.71	3.13	2.79	8.06	3.28	2.46
10	7.76	2.13	3.63	8.30	2.54	3.27	8.53	2.82	3.03	8.68	3.03	2.87	8.28	3.17	2.61
12	8.07	2.11	3.82	8.12	2.46	3.30	8.50	2.73	3.11	8.75	2.93	2.98	8.50	3.07	2.77
14	8.15	2.10	3.88	7.95	2.41	3.30	8.41	2.69	3.13	8.71	2.89	3.02	8.54	3.02	2.83
15	8.28	2.08	3.98	7.83	2.35	3.33	8.37	2.63	3.18	8.73	2.83	3.09	8.62	2.95	2.92
19	8.48	1.92	4.42	7.89	2.15	3.67	7.91	2.35	3.36	7.92	2.50	3.16	8.97	2.73	3.29
20	8.52	1.88	4.53	7.90	2.11	3.75	7.79	2.28	3.41	7.72	2.43	3.18	/	/	/
25	8.81	1.70	5.18	8.00	1.88	4.25	7.58	2.07	3.66	7.29	2.23	3.27	/	/	/
30	8.95	1.62	5.51	8.60	1.82	4.73	7.84	2.02	3.89	7.34	2.20	3.33	/	/	/
35	9.27	1.58	5.87	8.90	1.74	5.11	/	/	/	/	/	/	/	/	/
40	9.60	1.57	6.10	/	/	/	/	/	/	/	/	/	/	/	/
43	10.00	1.53	6.54	/	/	/	/	/	/	/	/	/	/	/	/

Abbreviations:

LWT: Leaving water temperature (°C)

DB: Dry-bulb temperature for Outdoor air temperature (°C)

HC: Total heating capacity (kW)

PI: Power input (kW)

Table 2-4.5-1: Heating capacity for 14kW models

Maximum															
DB	LWT														
	25			30			35			40			45		
	HC	PI	COP	HC	PI	COP	HC	PI	COP	HC	PI	COP	HC	PI	COP
-25	7.00	3.27	2.14	6.76	3.20	2.11	5.43	3.18	1.71	4.89	3.35	1.46	4.47	3.47	1.29
-20	8.36	3.25	2.57	8.01	3.18	2.52	7.79	3.58	2.18	6.89	3.65	1.89	6.25	3.61	1.73
-15	9.61	3.40	2.82	9.47	3.61	2.62	9.22	3.80	2.43	8.57	3.95	2.17	7.63	4.12	1.85
-10	11.88	3.81	3.12	11.42	4.18	2.73	10.95	4.44	2.47	10.60	4.70	2.26	9.64	4.73	2.04
-7	13.71	4.02	3.41	12.91	4.28	3.02	12.70	4.55	2.79	12.32	4.94	2.49	11.94	5.17	2.31
-5	13.90	3.78	3.68	13.19	3.87	3.41	12.76	4.27	2.99	12.56	4.61	2.73	12.07	4.99	2.42
-2	13.69	3.61	3.79	13.01	3.61	3.60	12.51	4.04	3.09	12.45	4.38	2.84	12.21	4.90	2.49
0	14.32	3.40	4.21	13.68	3.54	3.87	13.03	4.00	3.26	13.01	4.32	3.01	12.69	4.85	2.62
2	14.69	3.20	4.59	14.14	3.44	4.11	13.61	3.94	3.46	13.46	4.23	3.18	13.32	4.84	2.75
5	15.38	2.93	5.25	14.91	3.30	4.51	14.32	3.63	3.94	14.28	3.95	3.61	14.29	4.59	3.11
7	16.27	2.81	5.80	15.55	3.15	4.94	15.46	3.44	4.49	15.60	3.86	4.04	15.65	4.52	3.46
10	15.54	2.28	6.81	15.52	2.89	5.36	14.86	3.10	4.79	15.27	3.60	4.24	14.97	4.08	3.67
12	15.49	2.14	7.23	15.41	2.76	5.58	15.08	3.02	4.99	15.61	3.59	4.35	15.30	4.04	3.79
14	15.36	2.08	7.38	15.25	2.70	5.65	15.08	2.99	5.04	15.68	3.58	4.37	15.36	4.02	3.82
15	15.32	2.01	7.62	15.18	2.62	5.79	15.17	2.94	5.16	15.83	3.56	4.45	15.50	3.98	3.89
19	14.99	1.83	8.21	14.89	2.27	6.55	14.75	2.66	5.55	15.35	3.14	4.90	15.20	3.52	4.32
20	14.90	1.78	8.35	14.81	2.20	6.74	14.64	2.59	5.65	15.23	3.04	5.01	15.12	3.42	4.42
25	14.89	1.64	9.08	14.75	1.92	7.69	14.62	2.38	6.15	14.93	2.68	5.57	14.74	2.98	4.95
30	15.25	1.55	9.82	14.81	1.80	8.21	14.86	2.10	7.09	15.06	2.42	6.22	15.00	2.80	5.36
35	16.01	1.45	11.05	15.37	1.70	9.04	14.99	1.87	8.02	15.49	2.26	6.86	15.25	2.65	5.77
40	16.22	1.40	11.62	16.41	1.59	10.29	16.21	1.89	8.57	15.96	2.20	7.26	15.75	2.59	6.08
43	16.55	1.36	12.20	16.73	1.54	10.83	16.54	1.88	8.81	16.28	2.12	7.69	16.07	2.56	6.27
DB	LWT														
	50			55			58			60			65		
	HC	PI	COP	HC	PI	COP	HC	PI	COP	HC	PI	COP	HC	PI	COP
-25	/	/	/	/	/	/	/	/	/	/	/	/	/	/	/
-20	5.42	3.61	1.50	5.14	3.87	1.33	4.97	4.06	1.23	/	/	/	/	/	/
-15	7.01	4.32	1.62	6.46	4.58	1.41	6.19	4.84	1.28	6.01	5.05	1.19	/	/	/
-10	9.07	5.01	1.81	8.72	5.21	1.67	7.53	5.26	1.43	6.73	5.30	1.27	/	/	/
-7	11.04	5.33	2.07	11.27	5.61	2.01	9.32	5.45	1.71	8.02	5.31	1.51	/	/	/
-5	11.17	5.24	2.13	11.14	5.32	2.09	9.41	5.18	1.82	8.25	5.06	1.63	/	/	/
-2	11.39	5.07	2.25	11.36	5.23	2.17	9.80	5.26	1.86	8.76	5.28	1.66	/	/	/
0	11.89	4.99	2.38	11.80	5.19	2.27	10.32	5.34	1.93	9.34	5.48	1.70	/	/	/
2	12.68	5.13	2.47	12.62	5.27	2.39	11.28	5.44	2.07	10.38	5.58	1.86	/	/	/
5	13.80	4.98	2.77	13.78	5.18	2.66	12.53	5.29	2.37	11.70	5.38	2.17	9.76	5.33	1.83
7	14.97	4.81	3.11	14.53	5.14	2.83	13.73	5.08	2.70	13.20	5.20	2.54	10.38	4.95	2.10
10	15.31	4.62	3.31	14.15	4.60	3.08	13.58	4.77	2.84	13.20	4.91	2.69	11.23	4.98	2.26
12	15.39	4.50	3.42	13.63	4.31	3.16	13.27	4.53	2.93	13.02	4.70	2.77	11.60	4.96	2.34
14	15.32	4.45	3.44	13.27	4.17	3.18	13.01	4.42	2.95	12.84	4.60	2.79	11.69	4.96	2.36
15	15.34	4.37	3.51	12.99	4.02	3.24	12.84	4.28	3.00	12.74	4.48	2.84	11.86	4.97	2.41
19	15.06	3.94	3.83	12.78	3.69	3.46	11.91	3.81	3.12	11.34	3.91	2.90	12.53	4.80	2.61
20	14.99	3.84	3.90	12.73	3.62	3.52	11.68	3.70	3.16	10.99	3.77	2.92	/	/	/
25	14.72	3.43	4.30	12.47	3.28	3.80	11.08	3.35	3.31	10.16	3.40	2.99	/	/	/
30	14.61	3.14	4.65	12.80	2.93	4.37	11.32	3.17	3.57	10.34	3.40	3.04	/	/	/
35	14.78	2.95	5.00	13.01	2.77	4.69	/	/	/	/	/	/	/	/	/
40	14.95	2.78	5.38	/	/	/	/	/	/	/	/	/	/	/	/
43	15.15	2.73	5.54	/	/	/	/	/	/	/	/	/	/	/	/

Abbreviations:

LWT: Leaving water temperature (°C)

DB: Dry-bulb temperature for Outdoor air temperature (°C)

HC: Total heating capacity (kW)

PI: Power input (kW)

Table 2-4.5-2: Heating capacity for 14kW models

Normal															
DB	LWT														
	25			30			35			40			45		
	HC	PI	COP	HC	PI	COP	HC	PI	COP	HC	PI	COP	HC	PI	COP
-25	5.85	2.57	2.27	5.71	2.54	2.25	4.57	2.55	1.79	4.19	2.76	1.51	3.88	2.97	1.30
-20	7.27	2.63	2.77	7.27	2.67	2.72	6.75	2.92	2.32	6.07	3.06	1.99	5.48	3.08	1.78
-15	8.03	2.63	3.06	7.94	2.79	2.85	7.86	3.03	2.60	7.16	3.12	2.29	6.24	3.26	1.91
-10	9.80	2.96	3.31	9.36	3.22	2.91	8.89	3.43	2.59	8.76	3.74	2.34	8.07	3.85	2.09
-7	12.45	3.50	3.56	12.19	3.94	3.09	12.00	4.21	2.85	11.87	4.46	2.66	11.70	4.98	2.35
-5	12.05	3.05	3.95	11.84	3.29	3.60	11.87	3.88	3.06	11.70	4.08	2.87	11.68	4.73	2.47
-2	11.76	2.89	4.07	11.44	3.01	3.80	11.44	3.55	3.22	11.44	3.79	3.02	11.54	4.52	2.55
0	12.20	2.70	4.52	11.79	2.89	4.08	11.72	3.40	3.45	11.79	3.65	3.23	11.74	4.36	2.69
2	11.98	2.41	4.97	11.80	2.65	4.46	11.00	3.06	3.60	11.55	3.40	3.40	11.50	4.04	2.85
5	13.40	2.39	5.61	13.08	2.71	4.82	13.01	3.17	4.10	12.62	3.26	3.87	12.70	3.85	3.30
7	15.21	2.43	6.26	14.54	2.77	5.24	14.50	3.15	4.60	14.58	3.52	4.15	14.10	3.92	3.60
10	12.29	1.63	7.53	12.14	2.07	5.85	11.31	2.17	5.22	11.77	2.52	4.67	11.41	2.87	3.97
12	12.29	1.53	8.03	12.08	1.97	6.12	11.50	2.11	5.46	12.07	2.51	4.82	11.69	2.84	4.12
14	12.20	1.49	8.22	11.98	1.93	6.21	11.53	2.08	5.53	12.14	2.50	4.85	11.76	2.83	4.16
15	12.19	1.43	8.50	11.95	1.87	6.37	11.62	2.05	5.67	12.29	2.49	4.94	11.89	2.80	4.25
19	11.83	1.28	9.22	11.62	1.60	7.27	11.20	1.82	6.15	11.81	2.15	5.48	11.55	2.43	4.75
20	11.74	1.25	9.40	11.53	1.54	7.49	11.09	1.77	6.27	11.69	2.08	5.62	11.47	2.35	4.87
25	11.80	1.15	10.22	11.56	1.35	8.55	11.15	1.63	6.82	11.53	1.66	6.93	11.25	2.06	5.46
30	12.20	1.11	10.98	11.71	1.29	9.07	11.44	1.46	7.81	11.75	1.54	7.64	11.56	2.05	5.63
35	13.05	1.06	12.28	12.39	1.25	9.93	11.77	1.36	8.63	12.31	1.67	7.39	11.99	1.96	6.10
40	13.55	1.04	13.01	13.55	1.19	11.38	13.05	1.41	9.28	13.01	1.65	7.88	12.70	1.96	6.48
43	14.06	1.02	13.75	14.07	1.17	12.06	13.56	1.41	9.61	13.51	1.61	8.40	13.19	1.96	6.73
DB	LWT														
	50			55			58			60			65		
	HC	PI	COP	HC	PI	COP	HC	PI	COP	HC	PI	COP	HC	PI	COP
-25	/	/	/	/	/	/	/	/	/	/	/	/	/	/	/
-20	4.77	3.08	1.55	4.69	3.52	1.33	4.64	3.87	1.20	/	/	/	/	/	/
-15	5.76	3.42	1.68	5.41	3.81	1.42	5.22	4.09	1.28	5.09	4.31	1.18	/	/	/
-10	7.63	4.08	1.87	7.34	4.26	1.72	6.37	4.35	1.46	5.73	4.44	1.29	/	/	/
-7	10.86	5.15	2.11	11.00	5.37	2.05	8.84	5.05	1.75	7.41	4.77	1.55	/	/	/
-5	10.78	4.99	2.16	10.83	5.13	2.11	8.87	4.82	1.84	7.57	4.56	1.66	/	/	/
-2	10.80	4.73	2.28	10.87	4.95	2.19	9.05	4.78	1.89	7.85	4.64	1.69	/	/	/
0	11.08	4.57	2.42	11.13	4.84	2.30	9.36	4.77	1.96	8.18	4.70	1.74	/	/	/
2	12.14	4.86	2.50	12.40	5.06	2.45	10.10	4.77	2.12	8.56	4.46	1.92	/	/	/
5	12.50	4.40	2.84	12.57	4.57	2.75	10.61	4.31	2.46	9.31	4.11	2.27	8.06	4.19	1.93
7	14.00	4.40	3.18	13.80	4.68	2.95	12.93	4.67	2.77	12.34	4.73	2.61	9.71	4.50	2.16
10	11.42	3.30	3.46	10.64	3.31	3.21	10.44	3.54	2.95	10.31	3.71	2.78	9.11	3.88	2.35
12	11.51	3.21	3.59	10.28	3.10	3.32	10.23	3.35	3.05	10.20	3.54	2.88	9.43	3.83	2.46
14	11.48	3.17	3.62	10.03	3.00	3.35	10.05	3.26	3.08	10.07	3.47	2.90	9.53	3.82	2.50
15	11.52	3.11	3.70	9.84	2.88	3.41	9.94	3.16	3.14	10.01	3.38	2.96	9.68	3.78	2.56
19	11.21	2.76	4.07	9.59	2.61	3.68	9.14	2.77	3.30	8.83	2.90	3.05	10.29	3.65	2.82
20	11.13	2.68	4.16	9.53	2.55	3.74	8.94	2.68	3.34	8.54	2.78	3.07	/	/	/
25	11.00	2.41	4.58	9.40	2.32	4.04	8.53	2.43	3.50	7.95	2.53	3.14	/	/	/
30	11.03	2.24	4.92	9.74	2.13	4.56	8.80	2.36	3.73	8.17	2.58	3.17	/	/	/
35	11.38	2.13	5.33	10.09	2.05	4.93	/	/	/	/	/	/	/	/	/
40	11.81	2.04	5.78	/	/	/	/	/	/	/	/	/	/	/	/
43	12.20	2.04	5.99	/	/	/	/	/	/	/	/	/	/	/	/

Abbreviations:

LWT: Leaving water temperature (°C)

DB: Dry-bulb temperature for Outdoor air temperature (°C)

HC: Total heating capacity (kW)

PI: Power input (kW)

Table 2-4.5-3: Heating capacity for 14kW models

Minimum																
DB	LWT															
	25			30			35			40			45			
	HC	PI	COP	HC	PI	COP	HC	PI	COP	HC	PI	COP	HC	PI	COP	
-25	3.76	1.62	2.33	4.02	1.74	2.30	3.54	1.94	1.82	3.33	2.17	1.54	3.00	2.29	1.31	
-20	4.58	1.63	2.80	4.77	1.73	2.76	4.40	1.87	2.35	4.02	1.99	2.02	4.06	2.31	1.76	
-15	5.24	1.68	3.13	5.40	1.85	2.91	5.31	2.00	2.66	4.91	2.09	2.35	4.88	2.56	1.91	
-10	5.05	1.47	3.44	5.08	1.68	3.02	4.76	1.79	2.66	4.80	1.99	2.41	5.01	2.35	2.13	
-7	5.14	1.34	3.84	4.55	1.35	3.36	4.57	1.48	3.10	4.96	1.77	2.80	6.21	2.46	2.52	
-5	5.35	1.28	4.17	4.78	1.25	3.81	4.61	1.38	3.34	5.19	1.69	3.07	6.40	2.41	2.65	
-2	5.37	1.25	4.30	4.89	1.21	4.04	4.56	1.32	3.47	5.24	1.63	3.22	6.56	2.39	2.75	
0	5.73	1.19	4.80	5.34	1.22	4.36	4.79	1.31	3.66	5.57	1.63	3.42	6.92	2.39	2.90	
2	5.93	1.11	5.33	5.57	1.18	4.71	5.14	1.29	4.00	5.83	1.60	3.64	7.33	2.34	3.13	
5	6.23	1.03	6.07	5.89	1.14	5.15	5.58	1.24	4.49	6.18	1.49	4.16	7.86	2.25	3.49	
7	6.48	0.96	6.75	6.03	1.06	5.68	5.92	1.12	5.27	6.64	1.42	4.68	8.50	2.09	4.07	
10	6.34	0.80	7.93	6.18	1.00	6.16	5.84	1.06	5.50	6.66	1.35	4.92	8.28	2.00	4.15	
12	6.21	0.74	8.43	6.11	0.95	6.43	5.92	1.03	5.73	7.04	1.39	5.06	8.49	1.98	4.29	
14	6.09	0.71	8.62	6.02	0.92	6.52	5.91	1.02	5.80	7.16	1.41	5.09	8.51	1.97	4.33	
15	6.01	0.67	8.90	5.97	0.89	6.68	5.93	1.00	5.94	7.33	1.42	5.18	8.59	1.94	4.42	
19	5.96	0.62	9.65	5.93	0.78	7.61	5.85	0.91	6.45	7.19	1.25	5.74	8.50	1.72	4.93	
20	5.95	0.60	9.84	5.93	0.76	7.85	5.83	0.89	6.57	7.16	1.22	5.88	8.48	1.68	5.06	
25	6.09	0.57	10.70	6.05	0.68	8.95	5.96	0.83	7.15	7.17	1.10	6.54	8.42	1.48	5.67	
30	7.11	0.62	11.47	7.26	0.76	9.49	8.10	1.01	8.02	8.43	1.20	7.05	8.68	1.46	5.92	
35	7.63	0.59	13.00	7.69	0.73	10.52	8.32	0.91	9.15	8.83	1.13	7.84	8.98	1.40	6.42	
40	7.89	0.57	13.77	8.37	0.69	12.06	9.16	0.93	9.84	9.10	1.09	8.35	9.29	1.36	6.82	
43	8.30	0.57	14.55	8.79	0.69	12.78	9.59	0.94	10.19	9.53	1.07	8.90	9.24	1.31	7.08	
DB	LWT															
	50			55			58			60			65			
	HC	PI	COP	HC	PI	COP	HC	PI	COP	HC	PI	COP	HC	PI	COP	
-25	/	/	/	/	/	/	/	/	/	/	/	/	/	/	/	
-20	3.79	2.47	1.54	3.65	2.76	1.32	3.56	2.98	1.20	/	/	/	/	/	/	
-15	4.84	2.87	1.68	4.52	3.17	1.43	4.41	3.44	1.28	4.33	3.65	1.19	/	/	/	
-10	5.17	2.71	1.90	5.40	3.08	1.76	4.87	3.26	1.49	4.51	3.43	1.32	/	/	/	
-7	5.96	2.71	2.20	6.25	2.90	2.15	5.63	3.09	1.82	5.22	3.26	1.60	/	/	/	
-5	6.15	2.69	2.28	6.46	2.88	2.24	5.85	3.03	1.93	5.44	3.15	1.73	/	/	/	
-2	6.30	2.61	2.41	6.62	2.83	2.34	6.12	3.07	1.99	5.78	3.28	1.76	/	/	/	
0	6.61	2.58	2.57	6.90	2.81	2.46	6.46	3.12	2.07	6.17	3.39	1.82	/	/	/	
2	7.18	2.62	2.74	7.73	2.94	2.63	7.29	3.20	2.28	7.00	3.43	2.04	/	/	/	
5	7.86	2.59	3.03	8.68	2.98	2.91	8.24	3.20	2.58	7.95	3.38	2.35	6.88	3.44	2.00	
7	8.43	2.46	3.43	9.05	2.78	3.25	8.95	3.02	2.96	8.88	3.21	2.77	7.25	3.14	2.31	
10	8.77	2.40	3.65	8.96	2.67	3.36	8.99	2.91	3.09	9.02	3.10	2.91	7.95	3.23	2.46	
12	9.17	2.43	3.78	8.75	2.53	3.46	8.95	2.81	3.19	9.08	3.03	3.00	8.39	3.27	2.56	
14	9.29	2.44	3.81	8.57	2.46	3.49	8.85	2.76	3.21	9.04	2.99	3.03	8.53	3.29	2.59	
15	9.47	2.43	3.89	8.45	2.38	3.55	8.80	2.69	3.27	9.04	2.93	3.09	8.72	3.29	2.65	
19	9.38	2.20	4.27	8.38	2.19	3.83	8.22	2.39	3.43	8.11	2.56	3.17	9.49	3.27	2.90	
20	9.35	2.14	4.36	8.36	2.15	3.89	8.07	2.32	3.47	7.88	2.47	3.19	/	/	/	
25	9.33	1.94	4.80	8.32	1.98	4.21	7.76	2.13	3.65	7.38	2.26	3.27	/	/	/	
30	9.37	1.81	5.17	8.70	1.81	4.80	7.89	2.01	3.92	7.34	2.20	3.33	/	/	/	
35	9.63	1.72	5.61	8.97	1.73	5.19	/	/	/	/	/	/	/	/	/	
40	9.89	1.63	6.08	/	/	/	/	/	/	/	/	/	/	/	/	
43	10.25	1.63	6.30	/	/	/	/	/	/	/	/	/	/	/	/	

Abbreviations:

LWT: Leaving water temperature (°C)

DB: Dry-bulb temperature for Outdoor air temperature (°C)

HC: Total heating capacity (kW)

PI: Power input (kW)

Table 2-4.6-1: Heating capacity for 16kW models

Maximum															
DB	LWT														
	25			30			35			40			45		
	HC	PI	COP	HC	PI	COP	HC	PI	COP	HC	PI	COP	HC	PI	COP
-25	7.69	4.03	1.91	7986.00	4132.04	1.93	6.61	4.01	1.65	5.89	4.43	1.33	4.96	4.21	1.18
-20	9.57	4.02	2.38	9.71	4.43	2.19	8.16	4.77	1.71	7.48	4.76	1.57	6.55	4.85	1.35
-15	11.84	4.37	2.71	11.27	4.60	2.45	10.71	4.93	2.17	10.07	5.24	1.92	9.03	5.38	1.68
-10	13.40	4.51	2.97	13.03	4.79	2.72	12.68	5.10	2.49	12.42	5.45	2.28	11.05	5.64	1.96
-7	14.34	4.59	3.13	14.09	4.89	2.88	13.87	5.19	2.67	13.84	5.55	2.50	13.13	6.02	2.18
-5	14.55	4.19	3.47	14.25	4.55	3.13	13.98	4.88	2.86	13.84	5.31	2.61	13.38	5.88	2.28
-2	14.38	3.84	3.74	13.90	4.08	3.41	13.70	4.46	3.07	13.48	4.96	2.72	13.53	5.56	2.43
0	15.09	3.49	4.33	14.46	3.85	3.75	14.27	4.27	3.34	13.85	4.80	2.88	14.06	5.33	2.64
2	15.73	3.36	4.68	15.10	3.86	3.91	14.72	4.38	3.36	14.48	4.75	3.05	14.73	5.42	2.72
5	16.79	3.24	5.19	16.53	4.07	4.06	16.07	3.98	4.04	15.64	4.56	3.43	15.88	4.96	3.20
7	17.48	3.16	5.53	16.91	3.68	4.60	16.79	3.79	4.43	16.35	4.25	3.85	16.62	4.80	3.46
10	18.01	2.99	6.02	17.76	3.58	4.96	17.58	3.71	4.74	17.07	4.31	3.96	17.33	4.72	3.67
12	18.52	2.88	6.44	18.22	3.30	5.52	18.07	3.55	5.08	17.74	4.19	4.23	18.00	4.63	3.89
14	18.65	2.83	6.60	18.31	3.19	5.75	18.18	3.49	5.22	17.94	4.14	4.33	18.21	4.60	3.96
15	18.89	2.76	6.84	18.52	3.06	6.05	18.41	3.40	5.41	18.26	4.08	4.48	18.53	4.53	4.09
19	17.55	2.25	7.79	17.15	2.49	6.89	17.04	2.82	6.05	16.77	3.36	4.99	16.59	3.92	4.24
20	17.22	2.14	8.03	16.81	2.37	7.10	16.70	2.69	6.21	16.39	3.20	5.12	16.11	3.77	4.28
25	16.48	1.86	8.86	16.19	2.23	7.26	16.24	2.34	6.94	16.15	2.78	5.81	15.73	3.23	4.87
30	15.63	1.55	10.09	15.46	1.88	8.21	15.37	2.00	7.68	15.41	2.37	6.49	15.05	2.76	5.46
35	16.57	1.53	10.82	16.35	1.81	9.01	16.31	1.94	8.42	16.23	2.36	6.87	15.88	2.79	5.68
40	16.90	1.47	11.46	17.64	1.75	10.06	17.25	1.88	9.15	17.35	2.40	7.24	16.41	2.78	5.91
43	17.24	1.46	11.84	17.99	1.71	10.51	17.59	1.88	9.37	17.70	2.39	7.41	16.74	2.70	6.20
DB	LWT														
	50			55			58			60			65		
	HC	PI	COP	HC	PI	COP	HC	PI	COP	HC	PI	COP	HC	PI	COP
-25	/	/	/	/	/	/	/	/	/	/	/	/	/	/	/
-20	5.85	4.54	1.29	5.37	4.75	1.13	5.07	4.90	1.04	/	/	/	/	/	/
-15	7.53	5.32	1.42	6.82	5.29	1.29	6.58	5.46	1.21	6.42	5.59	1.15	/	/	/
-10	9.49	5.58	1.70	8.92	5.92	1.51	7.79	5.74	1.36	7.04	5.59	1.26	/	/	/
-7	12.86	6.22	2.07	12.50	6.25	2.00	9.94	6.17	1.61	8.25	6.18	1.33	/	/	/
-5	12.95	5.82	2.22	12.60	5.92	2.13	10.21	5.94	1.72	8.62	5.97	1.45	/	/	/
-2	13.02	5.53	2.35	12.59	5.75	2.19	10.47	5.75	1.82	9.06	5.74	1.58	/	/	/
0	13.42	5.35	2.51	12.84	5.66	2.27	10.87	5.60	1.94	9.56	5.54	1.72	/	/	/
2	14.08	5.40	2.61	13.65	5.74	2.38	12.08	5.78	2.09	11.03	5.82	1.89	/	/	/
5	15.26	5.05	3.02	14.47	5.21	2.77	13.42	5.29	2.53	12.71	5.36	2.37	10.71	5.24	2.04
7	16.20	5.11	3.17	16.20	5.70	2.84	14.91	5.45	2.74	14.06	5.34	2.63	11.28	5.13	2.20
10	16.69	5.12	3.26	16.05	5.16	3.11	15.01	5.14	2.92	14.32	5.13	2.79	12.23	4.97	2.46
12	17.33	4.96	3.50	16.82	5.14	3.27	15.48	5.05	3.07	14.59	4.98	2.93	12.40	4.89	2.54
14	17.52	4.89	3.59	17.09	5.14	3.33	15.61	5.01	3.12	14.62	4.92	2.97	12.40	4.86	2.55
15	17.83	4.79	3.72	17.46	5.11	3.42	15.83	4.95	3.20	14.75	4.83	3.06	12.47	4.80	2.60
19	15.26	4.21	3.63	15.45	4.48	3.45	14.26	4.48	3.19	13.46	4.47	3.01	12.76	4.58	2.79
20	14.62	4.06	3.60	14.95	4.32	3.46	13.86	4.36	3.18	13.14	4.39	3.00	/	/	/
25	14.52	3.46	4.20	14.06	3.68	3.82	13.26	3.93	3.37	12.73	4.15	3.07	/	/	/
30	14.31	2.99	4.79	13.56	3.24	4.18	12.83	3.63	3.53	12.34	3.98	3.10	/	/	/
35	15.00	3.00	5.01	13.37	3.07	4.35	/	/	/	/	/	/	/	/	/
40	15.58	2.98	5.22	/	/	/	/	/	/	/	/	/	/	/	/
43	15.89	2.94	5.41	/	/	/	/	/	/	/	/	/	/	/	/

Abbreviations:

LWT: Leaving water temperature (°C)

DB: Dry-bulb temperature for Outdoor air temperature (°C)

HC: Total heating capacity (kW)

PI: Power input (kW)

Table 2-4.6-2: Heating capacity for 16kW models

Normal															
DB	LWT														
	25			30			35			40			45		
	HC	PI	COP	HC	PI	COP	HC	PI	COP	HC	PI	COP	HC	PI	COP
-25	6.57	3.24	2.03	6.79	3.29	2.06	5.57	3.21	1.73	5.04	3.65	1.38	4.30	3.60	1.19
-20	8.42	3.29	2.56	8.50	3.59	2.37	7.07	3.88	1.82	6.59	3.99	1.65	5.74	4.14	1.39
-15	9.89	3.37	2.93	9.35	3.52	2.66	8.80	3.79	2.32	8.41	4.14	2.03	7.38	4.26	1.73
-10	11.06	3.51	3.15	10.69	3.68	2.90	10.30	3.95	2.61	10.26	4.34	2.37	9.25	4.59	2.01
-7	13.87	4.27	3.25	13.54	4.44	3.05	13.10	4.85	2.70	13.09	4.98	2.63	12.80	5.69	2.25
-5	13.71	3.85	3.56	13.62	4.13	3.30	13.20	4.47	2.95	13.12	4.86	2.70	12.73	5.49	2.32
-2	13.00	3.35	3.88	12.90	3.57	3.62	12.67	4.03	3.14	12.60	4.44	2.84	12.58	5.05	2.49
0	13.10	2.90	4.52	13.04	3.25	4.01	12.93	3.80	3.40	12.74	4.21	3.03	12.78	4.72	2.71
2	13.25	2.61	5.07	13.10	3.18	4.12	13.00	3.77	3.45	12.72	3.97	3.20	12.70	4.46	2.85
5	14.14	2.52	5.61	13.66	3.19	4.28	13.46	3.09	4.35	13.09	3.58	3.66	13.14	3.88	3.39
7	16.96	2.87	5.91	16.14	3.16	5.11	15.90	3.53	4.50	15.74	3.99	3.94	16.00	4.57	3.50
10	14.24	2.14	6.66	13.89	2.57	5.42	13.48	2.61	5.16	13.16	3.01	4.36	13.21	3.33	3.97
12	14.54	2.03	7.16	14.28	2.32	6.17	14.03	2.52	5.58	13.72	2.93	4.68	13.76	3.26	4.22
14	14.59	1.99	7.35	14.38	2.22	6.49	14.21	2.48	5.74	13.90	2.90	4.80	13.94	3.23	4.32
15	14.73	1.93	7.63	14.57	2.11	6.89	14.48	2.43	5.97	14.18	2.85	4.98	14.21	3.19	4.46
19	13.56	1.55	8.76	13.44	1.75	7.69	13.26	1.98	6.70	12.95	2.32	5.59	12.62	2.71	4.66
20	13.27	1.47	9.04	13.16	1.67	7.89	12.95	1.88	6.88	12.65	2.20	5.75	12.22	2.59	4.71
25	12.82	1.29	9.97	12.68	1.57	8.06	12.73	1.65	7.71	12.67	1.75	7.22	12.01	2.24	5.36
30	12.51	1.11	11.29	12.23	1.35	9.06	11.83	1.40	8.47	12.41	1.55	7.98	11.83	2.06	5.74
35	13.36	1.11	12.03	13.24	1.34	9.90	12.80	1.41	9.06	13.22	1.79	7.40	12.48	2.07	6.02
40	14.11	1.10	12.83	14.57	1.31	11.13	13.88	1.40	9.91	14.14	1.80	7.86	13.22	2.10	6.30
43	14.65	1.10	13.33	15.13	1.29	11.71	14.43	1.41	10.21	14.69	1.81	8.10	13.74	2.06	6.66

DB	LWT														
	50			55			58			60			65		
	HC	PI	COP	HC	PI	COP	HC	PI	COP	HC	PI	COP	HC	PI	COP
-25	/	/	/	/	/	/	/	/	/	/	/	/	/	/	/
-20	5.15	3.88	1.33	4.89	4.33	1.13	4.74	4.68	1.01	/	/	/	/	/	/
-15	6.18	4.21	1.47	5.71	4.40	1.30	5.54	4.61	1.20	5.43	4.77	1.14	/	/	/
-10	7.98	4.55	1.75	7.51	4.83	1.55	6.60	4.75	1.39	5.99	4.69	1.28	/	/	/
-7	12.38	5.83	2.12	12.50	6.25	2.00	9.61	5.89	1.63	7.69	5.60	1.37	/	/	/
-5	12.41	5.51	2.25	9.98	4.50	2.22	8.72	4.91	1.77	7.88	5.32	1.48	/	/	/
-2	12.49	5.19	2.41	9.78	4.26	2.29	8.73	4.63	1.88	8.04	4.99	1.61	/	/	/
0	12.88	4.97	2.59	9.77	4.09	2.39	8.86	4.40	2.01	8.26	4.69	1.76	/	/	/
2	13.02	4.88	2.67	13.30	5.54	2.40	10.71	4.95	2.17	8.92	4.44	2.01	/	/	/
5	13.22	4.25	3.11	13.50	4.74	2.85	11.47	4.37	2.62	10.12	4.09	2.47	8.84	4.24	2.08
7	15.97	4.92	3.24	16.00	5.61	2.85	14.31	5.13	2.79	13.19	4.86	2.72	10.24	4.60	2.23
10	12.45	3.66	3.41	12.07	3.71	3.25	11.53	3.81	3.03	11.18	3.88	2.88	9.92	3.93	2.52
12	12.96	3.53	3.67	12.69	3.69	3.44	11.93	3.73	3.20	11.43	3.76	3.04	10.08	3.88	2.60
14	13.14	3.48	3.77	12.91	3.69	3.50	12.05	3.70	3.26	11.47	3.71	3.09	10.10	3.85	2.62
15	13.39	3.41	3.92	13.22	3.67	3.61	12.24	3.65	3.35	11.59	3.64	3.19	10.18	3.81	2.67
19	11.36	2.95	3.85	11.60	3.16	3.67	10.93	3.25	3.36	10.49	3.32	3.16	10.49	3.65	2.87
20	10.85	2.83	3.84	11.19	3.04	3.68	10.61	3.15	3.36	10.22	3.24	3.15	/	/	/
25	10.85	2.43	4.47	10.59	2.60	4.07	10.07	2.83	3.57	9.73	3.01	3.23	/	/	/
30	10.88	2.15	5.07	10.02	2.29	4.37	10.05	2.73	3.68	10.06	3.12	3.23	/	/	/
35	11.55	2.16	5.34	10.38	2.27	4.57	/	/	/	/	/	/	/	/	/
40	12.31	2.19	5.61	/	/	/	/	/	/	/	/	/	/	/	/
43	12.79	2.19	5.85	/	/	/	/	/	/	/	/	/	/	/	/

Abbreviations:

LWT: Leaving water temperature (°C)

DB: Dry-bulb temperature for Outdoor air temperature (°C)

HC: Total heating capacity (kW)

PI: Power input (kW)

Table 2-4.6-3: Heating capacity for 16kW models

Minimum																
DB	LWT															
	25			30			35			40			45			
	HC	PI	COP	HC	PI	COP	HC	PI	COP	HC	PI	COP	HC	PI	COP	
-25	4.38	2.11	2.08	4.74	2.25	2.11	4.30	2.45	1.76	4.01	2.86	1.40	3.33	2.77	1.20	
-20	5.31	2.04	2.60	5.58	2.33	2.40	4.61	2.50	1.85	4.36	2.60	1.68	4.25	3.10	1.37	
-15	6.45	2.15	3.00	6.37	2.34	2.72	5.94	2.50	2.38	5.77	2.77	2.08	5.78	3.33	1.73	
-10	5.70	1.74	3.27	5.80	1.93	3.01	5.52	2.06	2.68	5.63	2.31	2.43	5.75	2.80	2.05	
-7	5.38	1.53	3.52	4.96	1.55	3.21	4.99	1.68	2.97	5.58	1.99	2.80	6.83	2.86	2.38	
-5	5.60	1.43	3.93	5.16	1.47	3.50	5.17	1.62	3.20	5.72	1.94	2.94	7.09	2.84	2.50	
-2	5.64	1.33	4.26	5.22	1.36	3.83	5.17	1.50	3.44	5.67	1.84	3.08	7.27	2.71	2.68	
0	6.04	1.22	4.94	5.62	1.33	4.23	5.49	1.46	3.76	5.93	1.81	3.28	7.66	2.62	2.92	
2	6.35	1.18	5.39	5.69	1.31	4.34	5.82	1.42	4.10	6.28	1.77	3.56	8.12	2.55	3.19	
5	6.80	1.13	5.99	5.78	1.25	4.64	6.27	1.36	4.60	6.77	1.71	3.95	8.74	2.43	3.59	
7	6.96	1.08	6.43	5.67	1.05	5.38	6.43	1.27	5.08	6.97	1.56	4.46	9.02	2.26	3.99	
10	6.51	0.93	7.01	6.78	1.19	5.70	6.93	1.27	5.44	7.44	1.62	4.59	9.58	2.31	4.15	
12	6.65	0.89	7.51	6.84	1.06	6.48	7.15	1.22	5.86	7.99	1.63	4.92	9.98	2.27	4.40	
14	6.66	0.86	7.71	6.81	1.00	6.81	7.20	1.20	6.02	8.20	1.63	5.04	10.09	2.25	4.49	
15	6.71	0.84	7.99	6.82	0.94	7.22	7.29	1.17	6.26	8.45	1.62	5.22	10.26	2.21	4.64	
19	6.76	0.74	9.17	6.86	0.85	8.06	7.10	1.01	7.02	8.23	1.41	5.86	9.28	1.92	4.84	
20	6.77	0.72	9.46	6.86	0.83	8.27	7.05	0.98	7.21	8.17	1.36	6.02	9.04	1.85	4.89	
25	6.92	0.66	10.44	7.00	0.83	8.45	7.34	0.91	8.07	7.99	1.17	6.82	8.98	1.61	5.57	
30	7.29	0.62	11.79	7.58	0.80	9.48	8.38	0.96	8.70	8.91	1.21	7.36	8.88	1.47	6.03	
35	7.75	0.61	12.73	8.28	0.79	10.48	9.05	0.94	9.60	9.48	1.21	7.85	9.34	1.48	6.33	
40	8.22	0.61	13.58	9.00	0.76	11.79	9.75	0.93	10.51	9.89	1.19	8.34	9.68	1.46	6.62	
43	8.64	0.61	14.11	9.45	0.76	12.40	10.20	0.94	10.83	10.35	1.21	8.59	10.21	1.46	7.00	
DB	LWT															
	50			55			58			60			65			
	HC	PI	COP	HC	PI	COP	HC	PI	COP	HC	PI	COP	HC	PI	COP	
-25	/	/	/	/	/	/	/	/	/	/	/	/	/	/	/	
-20	4.10	3.11	1.32	3.81	3.38	1.13	3.64	3.60	1.01	/	/	/	/	/	/	
-15	5.20	3.54	1.47	4.78	3.66	1.30	4.69	3.88	1.21	4.62	4.04	1.15	/	/	/	
-10	5.41	3.03	1.79	5.53	3.49	1.58	5.04	3.56	1.42	4.71	3.62	1.30	/	/	/	
-7	6.94	3.17	2.19	7.11	3.27	2.17	6.06	3.53	1.72	5.36	3.80	1.41	/	/	/	
-5	7.12	3.00	2.37	7.31	3.20	2.28	6.34	3.46	1.83	5.69	3.72	1.53	/	/	/	
-2	7.26	2.85	2.55	7.34	3.11	2.36	6.52	3.35	1.95	5.98	3.57	1.68	/	/	/	
0	7.58	2.76	2.75	7.52	3.06	2.46	6.80	3.26	2.09	6.32	3.43	1.84	/	/	/	
2	8.06	2.79	2.89	8.23	3.09	2.67	7.74	3.27	2.36	7.41	3.43	2.16	/	/	/	
5	8.70	2.69	3.24	9.11	3.00	3.04	8.83	3.20	2.76	8.65	3.36	2.57	7.55	3.51	2.15	
7	9.01	2.58	3.49	9.96	3.13	3.19	9.66	3.22	3.00	9.46	3.29	2.87	7.87	3.41	2.31	
10	9.56	2.66	3.59	10.16	2.99	3.40	9.93	3.13	3.17	9.78	3.24	3.02	8.66	3.38	2.56	
12	10.34	2.68	3.86	10.82	3.02	3.58	10.44	3.13	3.34	10.18	3.21	3.17	8.97	3.39	2.65	
14	10.64	2.68	3.97	11.05	3.03	3.65	10.60	3.12	3.39	10.30	3.19	3.23	9.04	3.39	2.67	
15	11.00	2.67	4.12	11.35	3.02	3.75	10.82	3.10	3.49	10.47	3.16	3.32	9.17	3.37	2.72	
19	9.50	2.35	4.05	10.13	2.66	3.81	9.83	2.81	3.50	9.63	2.93	3.29	9.68	3.30	2.93	
20	9.12	2.26	4.03	9.82	2.57	3.83	9.58	2.74	3.50	9.42	2.87	3.28	/	/	/	
25	9.20	1.96	4.69	9.38	2.22	4.23	9.17	2.47	3.71	9.04	2.69	3.36	/	/	/	
30	9.25	1.74	5.33	8.95	1.95	4.59	9.01	2.32	3.88	9.05	2.66	3.40	/	/	/	
35	9.77	1.74	5.61	9.23	1.92	4.81	/	/	/	/	/	/	/	/	/	
40	10.30	1.75	5.90	/	/	/	/	/	/	/	/	/	/	/	/	
43	10.75	1.75	6.15	/	/	/	/	/	/	/	/	/	/	/	/	

Abbreviations:

LWT: Leaving water temperature (°C)

DB: Dry-bulb temperature for Outdoor air temperature (°C)

HC: Total heating capacity (kW)

PI: Power input (kW)

Mono

4.2 Cooling Capacity Tables (Test standard: EN14511)

Table 2-4.7: KHC-06RY1-B cooling capacity

Maximum																										
DB	LWT																									
	5			7			10			11			15			18			20			25				
	CC	PI	EER	CC	PI	EER	CC	PI	EER	CC	PI	EER	CC	PI	EER	CC	PI	EER	CC	PI	EER	CC	PI	EER		
-5	/	/	/	/	/	/	/	/	/	/	/	/	5.27	0.59	8.93	5.91	0.57	10.42	6.38	0.55	11.53	6.77	0.64	10.62		
0	/	/	/	/	/	/	/	/	/	/	/	/	5.05	0.69	7.28	5.68	0.67	8.49	6.16	0.66	9.39	6.55	0.74	8.85		
5	/	/	/	/	/	/	/	/	/	/	/	/	4.55	0.79	5.74	5.17	0.77	6.73	5.66	0.76	7.48	6.05	0.84	7.20		
10	/	/	/	/	/	/	/	/	/	5.81	1.25	4.65	6.32	1.13	5.61	6.70	1.06	6.33	6.90	1.01	6.83	7.45	0.95	7.88		
15	/	/	/	/	/	/	5.89	1.10	5.33	6.33	1.18	5.38	8.09	1.46	5.55	8.13	1.33	6.10	8.14	1.26	6.44	8.85	1.05	8.43		
19	5.06	1.29	3.93	5.87	1.36	4.31	6.48	1.36	4.76	6.81	1.39	4.91	8.14	1.49	5.48	8.25	1.36	6.06	8.29	1.29	6.42	8.96	1.09	8.21		
20	5.41	1.38	3.93	6.10	1.43	4.27	6.63	1.43	4.62	6.93	1.45	4.79	8.16	1.49	5.47	8.28	1.37	6.05	8.33	1.30	6.42	8.98	1.10	8.15		
25	7.16	1.80	3.98	7.26	1.79	4.07	7.37	1.77	4.17	7.54	1.71	4.42	8.23	1.53	5.39	8.41	1.40	6.00	8.52	1.33	6.40	9.12	1.15	7.90		
30	6.50	1.85	3.51	7.15	1.95	3.67	7.29	1.90	3.84	7.39	1.84	4.02	7.77	1.65	4.72	8.09	1.54	5.27	8.19	1.46	5.63	8.77	1.30	6.75		
35	6.04	2.09	2.89	7.11	2.39	2.97	7.22	2.03	3.55	7.24	1.95	3.71	7.31	1.68	4.35	7.65	1.64	4.67	7.87	1.58	4.98	8.43	1.44	5.84		
40	3.80	1.51	2.52	4.50	1.69	2.66	5.08	1.81	2.81	5.25	1.79	2.93	5.91	1.73	3.41	6.36	1.70	3.75	6.63	1.68	3.95	7.88	1.64	4.80		
43	2.58	1.15	2.24	3.24	1.37	2.37	3.80	1.52	2.51	4.06	1.53	2.66	5.08	1.56	3.26	5.56	1.56	3.56	5.88	1.57	3.74	7.55	1.59	4.73		
Normal																										
DB	LWT																									
	5			7			10			11			15			18			20			25				
	CC	PI	EER	CC	PI	EER	CC	PI	EER	CC	PI	EER	CC	PI	EER	CC	PI	EER	CC	PI	EER	CC	PI	EER	CC	PI
-5	/	/	/	/	/	/	/	/	/	/	/	/	4.24	0.42	10.18	4.76	0.39	12.12	5.19	0.38	13.72	5.50	0.42	12.96		
0	/	/	/	/	/	/	/	/	/	/	/	/	4.07	0.48	8.48	4.59	0.46	10.08	5.02	0.44	11.39	5.33	0.48	11.01		
5	/	/	/	/	/	/	/	/	/	/	/	/	3.64	0.58	6.31	4.13	0.55	7.56	4.54	0.53	8.61	4.91	0.58	8.49		
10	/	/	/	/	/	/	/	/	/	4.69	0.95	4.93	5.08	0.82	6.18	5.37	0.75	7.12	5.55	0.71	7.86	6.06	0.65	9.31		
15	/	/	/	/	/	/	4.42	0.78	5.65	4.89	0.86	5.69	6.79	1.15	5.89	6.91	1.05	6.56	7.00	0.99	7.06	7.44	0.80	9.29		
19	3.93	0.95	4.12	4.62	1.01	4.58	5.17	1.01	5.10	5.50	1.05	5.25	6.80	1.16	5.88	6.99	1.07	6.51	7.14	1.03	6.96	7.74	0.86	9.04		
20	4.22	1.02	4.14	4.84	1.07	4.54	5.36	1.08	4.96	5.65	1.10	5.14	6.80	1.16	5.88	7.01	1.08	6.50	7.17	1.03	6.94	7.82	0.87	8.98		
25	5.67	1.35	4.21	5.92	1.36	4.34	6.05	1.35	4.49	6.23	1.31	4.74	6.96	1.21	5.74	7.27	1.13	6.45	7.44	1.07	6.98	8.05	0.91	8.85		
30	5.23	1.40	3.74	5.82	1.49	3.91	6.08	1.48	4.10	6.20	1.44	4.29	6.67	1.32	5.06	7.03	1.25	5.63	7.25	1.20	6.05	7.85	1.06	7.44		
35	4.74	1.61	2.94	7.00	2.33	3.00	6.85	1.87	3.67	6.86	1.78	3.85	6.87	1.50	4.58	6.50	1.35	4.80	6.87	1.28	5.36	7.69	1.20	6.39		
40	3.10	1.15	2.70	3.74	1.31	2.86	4.30	1.42	3.03	4.47	1.41	3.16	5.15	1.40	3.68	5.60	1.38	4.07	5.95	1.37	4.34	7.15	1.32	5.41		
43	2.12	0.91	2.33	2.58	1.05	2.46	2.99	1.15	2.59	3.20	1.16	2.76	4.04	1.18	3.43	4.58	1.21	3.79	5.04	1.25	4.04	5.97	1.15	5.18		
Minimum																										
DB	LWT																									
	5			7			10			11			15			18			20			25				
	CC	PI	EER	CC	PI	EER	CC	PI	EER	CC	PI	EER	CC	PI	EER	CC	PI	EER	CC	PI	EER	CC	PI	EER	CC	PI
-5	/	/	/	/	/	/	/	/	/	/	/	/	2.75	0.25	10.92	3.07	0.24	12.69	3.35	0.23	14.26	3.57	0.27	13.17		
0	/	/	/	/	/	/	/	/	/	/	/	/	2.64	0.29	9.00	2.96	0.28	10.44	3.25	0.28	11.72	3.47	0.31	11.08		
5	/	/	/	/	/	/	/	/	/	/	/	/	1.96	0.28	6.95	2.22	0.27	8.12	2.46	0.27	9.16	2.64	0.30	8.84		
10	/	/	/	/	/	/	/	/	/	2.60	0.45	5.73	2.81	0.41	6.87	2.98	0.39	7.72	3.10	0.37	8.44	3.36	0.34	9.78		
15	/	/	/	/	/	/	2.71	0.45	5.99	2.89	0.48	6.05	3.64	0.58	6.29	3.58	0.50	7.10	3.50	0.45	7.80	4.25	0.41	10.32		
19	2.07	0.48	4.29	2.20	0.46	4.77	2.42	0.45	5.34	2.62	0.47	5.52	3.43	0.55	6.24	3.66	0.53	6.88	3.86	0.52	7.41	4.40	0.46	9.66		
20	2.13	0.50	4.30	2.25	0.48	4.72	2.35	0.45	5.17	2.55	0.47	5.39	3.38	0.54	6.23	3.68	0.54	6.83	3.95	0.54	7.32	4.44	0.47	9.50		
25	2.42	0.56	4.31	2.49	0.55	4.50	2.50	0.53	4.72	2.66	0.53	4.98	3.29	0.54	6.04	3.63	0.54	6.74	3.92	0.53	7.33	4.38	0.47	9.28		
30	2.48	0.65	3.81	2.49	0.61	4.05	2.49	0.58	4.30	2.62	0.58	4.50	3.12	0.59	5.30	3.48	0.59	5.89	3.79	0.59	6.38	4.23	0.55	7.72		
35	2.07	0.62	3.31	2.44	0.67	3.65	2.75	0.69	4.00	2.80	0.67	4.20	3.01	0.60	4.99	3.35	0.60	5.62	3.66	0.63	5.81	4.23	0.62	6.84		
40	1.40	0.52	2.69	1.73	0.60	2.90	2.01	0.64	3.12	2.11	0.65	3.26	2.52	0.66	3.82	2.87	0.68	4.19	3.18	0.71	4.50	4.07	0.74	5.51		
43	0.73	0.31	2.38	1.09	0.43	2.52	1.43	0.53	2.68	1.57	0.55	2.86	2.11	0.59	3.57	2.35	0.60	3.90	2.57	0.62	4.17	3.80	0.71	5.38		

Abbreviations:

LWT: Leaving water temperature (°C)

DB: Dry-bulb temperature for Outdoor air temperature (°C)

CC: Total cooling capacity (kW)

PI: Power input (kW)

Table 2-4.8: KHC-08RY3-B cooling capacity

Maximum																								
DB	LWT																							
	5			7			10			11			15			18			20			25		
	CC	PI	EER	CC	PI	EER	CC	PI	EER	CC	PI	EER	CC	PI	EER	CC	PI	EER	CC	PI	EER	CC	PI	EER
-5	/	/	/	/	/	/	/	/	/	/	/	/	6.39	0.63	10.07	7.40	0.70	10.51	8.21	0.76	10.82	8.74	0.71	12.31
0	/	/	/	/	/	/	/	/	/	/	/	/	6.17	0.71	8.69	6.81	0.73	9.28	7.26	0.74	9.76	7.76	0.70	11.05
5	/	/	/	/	/	/	/	/	/	/	/	/	5.96	0.82	7.30	6.21	0.77	8.04	6.30	0.72	8.69	6.78	0.69	9.78
10	/	/	/	/	/	/	/	/	/	5.07	0.65	7.86	6.29	0.74	8.54	7.20	0.80	9.05	7.91	0.84	9.45	8.30	0.79	10.53
15	/	/	/	/	/	/	5.97	0.87	6.84	6.24	0.90	6.95	7.33	0.99	7.38	8.34	1.08	7.71	9.11	1.15	7.94	9.73	1.12	8.67
19	5.52	1.09	5.08	6.31	1.19	5.30	6.84	1.19	5.74	7.11	1.21	5.88	8.17	1.27	6.45	9.25	1.39	6.63	10.1	1.50	6.73	10.9	1.51	7.18
20	5.68	1.15	4.96	6.46	1.25	5.18	7.06	1.29	5.46	7.33	1.31	5.61	8.38	1.35	6.22	9.47	1.49	6.36	10.3	1.60	6.43	11.6	1.64	6.81
25	6.47	1.48	4.36	7.25	1.59	4.56	7.82	1.63	4.81	8.11	1.64	4.95	9.26	1.68	5.52	10.4	1.81	5.75	11.3	1.90	5.92	12.8	2.02	6.33
30	7.27	1.89	3.85	8.03	1.99	4.03	8.57	2.01	4.25	8.89	2.02	4.39	10.2	2.06	4.93	11.3	2.15	5.26	12.2	2.20	5.54	14.4	2.40	6.00
35	7.39	2.37	3.12	8.20	2.55	3.21	8.77	2.31	3.80	9.06	2.31	3.93	10.2	2.31	4.43	11.1	2.37	4.69	11.7	2.40	4.89	13.6	2.50	5.42
40	6.61	2.52	2.62	7.11	2.49	2.86	7.42	2.37	3.14	7.71	2.40	3.21	8.88	2.53	3.51	9.69	2.54	3.81	10.2	2.51	4.07	12.3	2.83	4.34
43	5.09	2.28	2.23	5.44	2.28	2.39	5.64	2.19	2.58	5.86	2.17	2.70	6.73	2.13	3.16	7.55	2.17	3.48	8.15	2.17	3.75	10.0 ₄	2.49	4.03

Normal																								
DB	LWT																							
	5			7			10			11			15			18			20			25		
	CC	PI	EER	CC	PI	EER	CC	PI	EER	CC	PI	EER	CC	PI	EER	CC	PI	EER	CC	PI	EER	CC	PI	EER
-5	/	/	/	/	/	/	/	/	/	/	/	/	5.14	0.45	11.38	5.97	0.50	12.01	6.68	0.53	12.50	7.10	0.51	14.03
0	/	/	/	/	/	/	/	/	/	/	/	/	4.98	0.50	9.94	5.50	0.51	10.69	5.91	0.52	11.31	6.31	0.49	12.86
5	/	/	/	/	/	/	/	/	/	/	/	/	4.77	0.60	7.96	4.96	0.56	8.88	5.05	0.52	9.69	5.50	0.51	10.76
10	/	/	/	/	/	/	/	/	/	4.10	0.49	8.42	5.05	0.54	9.32	5.77	0.58	10.00	6.37	0.60	10.55	6.75	0.58	11.60
15	/	/	/	/	/	/	4.48	0.62	7.24	4.82	0.65	7.36	6.16	0.79	7.83	7.07	0.85	8.32	7.83	0.90	8.70	8.17	0.86	9.55
19	4.29	0.80	5.34	4.98	0.88	5.64	5.46	0.89	6.14	5.74	0.91	6.29	6.82	0.99	6.92	7.82	1.09	7.15	8.66	1.19	7.30	9.40	1.19	7.91
20	4.43	0.85	5.21	5.12	0.93	5.52	5.71	0.97	5.86	5.97	0.99	6.03	6.99	1.04	6.69	8.01	1.17	6.86	8.87	1.28	6.95	9.71	1.29	7.50
25	5.13	1.11	4.61	5.83	1.20	4.87	6.42	1.24	5.17	6.70	1.26	5.31	7.84	1.33	5.87	8.92	1.44	6.20	9.82	1.52	6.46	11.3	1.59	7.09
30	5.84	1.42	4.10	6.56	1.52	4.31	7.14	1.57	4.54	7.45	1.59	4.69	8.71	1.65	5.28	9.85	1.74	5.65	10.8 ₀	1.82	5.94	12.9	1.95	6.61
35	5.75	1.79	3.20	7.45	2.22	3.35	7.70	1.89	4.07	7.82	1.86	4.21	8.32	1.74	4.77	8.30	1.64	5.05	10.2 ₅	1.95	5.26	12.4	2.09	5.94
40	5.40	1.92	2.81	5.89	1.91	3.08	6.27	1.86	3.38	6.56	1.90	3.46	7.73	2.04	3.79	8.54	2.06	4.15	9.18	2.06	4.47	11.1	2.28	4.89
43	4.18	1.80	2.32	4.35	1.75	2.49	4.44	1.66	2.67	4.62	1.65	2.80	5.36	1.61	3.32	6.23	1.68	3.71	6.98	1.72	4.06	7.94	1.80	4.41

Minimum																								
DB	LWT																							
	5			7			10			11			15			18			20			25		
	CC	PI	EER	CC	PI	EER	CC	PI	EER	CC	PI	EER	CC	PI	EER	CC	PI	EER	CC	PI	EER	CC	PI	EER
-5	/	/	/	/	/	/	/	/	/	/	/	/	3.33	0.28	11.86	3.84	0.31	12.42	4.31	0.33	12.89	4.60	0.31	14.71
0	/	/	/	/	/	/	/	/	/	/	/	/	3.23	0.31	10.38	3.55	0.32	11.13	3.83	0.32	11.79	4.11	0.31	13.34
5	/	/	/	/	/	/	/	/	/	/	/	/	2.57	0.30	8.55	2.67	0.28	9.46	2.74	0.27	10.29	2.96	0.26	11.57
10	/	/	/	/	/	/	/	/	/	2.27	0.25	9.25	2.80	0.28	10.11	3.20	0.30	10.75	3.56	0.31	11.31	3.75	0.30	12.59
15	/	/	/	/	/	/	2.75	0.36	7.69	2.86	0.37	7.82	3.30	0.39	8.37	3.63	0.40	9.03	3.92	0.41	9.62	4.67	0.44	10.61
19	2.19	0.40	5.55	2.34	0.40	5.87	2.55	0.40	6.43	2.73	0.41	6.61	3.44	0.47	7.35	4.09	0.54	7.60	4.69	0.60	7.79	5.34	0.63	8.47
20	2.24	0.41	5.42	2.38	0.42	5.73	2.50	0.41	6.12	2.69	0.43	6.31	3.47	0.49	7.09	4.20	0.58	7.24	4.88	0.67	7.33	5.51	0.69	7.93
25	2.46	0.52	4.73	2.57	0.51	5.05	2.66	0.49	5.43	2.87	0.51	5.58	3.71	0.60	6.18	4.47	0.69	6.51	5.18	0.76	6.78	6.12	0.82	7.44
30	2.78	0.66	4.19	2.86	0.64	4.45	2.93	0.62	4.76	3.16	0.64	4.91	4.08	0.74	5.53	4.89	0.82	5.93	5.64	0.90	6.28	6.92	1.01	6.86
35	2.62	0.74	3.54	2.99	0.77	3.89	3.34	0.78	4.28	3.51	0.79	4.45	4.21	0.82	5.12	4.86	0.90	5.43	5.46	0.96	5.70	6.82	1.07	6.36
40	2.44	0.87	2.80	2.70	0.86	3.12	2.94	0.84	3.48	3.11	0.87	3.57	3.79	0.97	3.93	4.38	1.02	4.30	4.91	1.06	4.64	6.34	1.28	4.97
43	1.43	0.60	2.37	1.78	0.70	2.55	2.12	0.77	2.76	2.26	0.78	2.90	2.80	0.81	3.46	3.20	0.83	3.84	3.55	0.85	4.18	5.06	1.11	4.58

Abbreviations:

LWT: Leaving water temperature (°C)

DB: Dry-bulb temperature for Outdoor air temperature (°C)

CC: Total cooling capacity (kW)

PI: Power input (kW)

Table 2-4.9: KHC-10RY3-B cooling capacity

Maximum																										
DB	LWT																									
	5			7			10			11			15			18			20			25				
	CC	PI	EER	CC	PI	EER	CC	PI	EER	CC	PI	EER	CC	PI	EER	CC	PI	EER	CC	PI	EER	CC	PI	EER		
-5	/	/	/	/	/	/	/	/	/	/	/	/	6.83	0.69	9.92	7.94	0.77	10.35	8.79	0.82	10.66	9.35	0.77	12.13		
0	/	/	/	/	/	/	/	/	/	/	/	/	6.61	0.77	8.56	7.30	0.80	9.14	7.76	0.81	9.61	8.30	0.76	10.88		
5	/	/	/	/	/	/	/	/	/	/	/	/	6.38	0.89	7.19	6.66	0.84	7.92	6.74	0.79	8.56	7.25	0.75	9.63		
10	/	/	/	/	/	/	/	/	/	/	/	5.30	0.69	7.69	6.55	0.75	8.73	7.48	0.79	9.51	8.17	0.80	10.18	8.80	0.86	10.22
15	/	/	/	/	/	/	6.30	1.07	5.89	6.56	1.06	6.18	7.61	1.03	7.35	8.68	1.10	7.91	9.48	1.13	8.38	10.64	1.20	8.84		
19	6.01	1.21	4.98	6.52	1.28	5.11	7.01	1.32	5.31	7.30	1.33	5.50	8.46	1.35	6.25	9.64	1.45	6.63	10.53	1.52	6.93	12.12	1.57	7.73		
20	6.20	1.28	4.86	6.72	1.35	4.98	7.19	1.39	5.17	7.49	1.40	5.33	8.67	1.45	5.97	9.88	1.57	6.31	10.79	1.64	6.57	12.49	1.68	7.45		
25	7.13	1.68	4.24	7.73	1.77	4.37	8.26	1.81	4.56	8.59	1.83	4.70	9.87	1.88	5.24	11.11	2.00	5.55	12.00	2.07	5.79	13.93	2.17	6.42		
30	8.06	2.17	3.71	8.63	2.24	3.86	9.34	2.31	4.05	9.68	2.33	4.16	11.08	2.40	4.62	12.34	2.51	4.91	13.21	2.57	5.14	15.37	2.79	5.51		
35	8.13	2.70	3.01	8.53	2.72	3.13	9.48	2.43	3.72	9.79	2.57	3.82	11.03	2.62	4.21	12.05	2.68	4.49	12.70	2.68	4.73	14.51	2.87	5.06		
40	6.61	2.52	2.62	7.04	2.46	2.86	7.42	2.37	3.14	7.71	2.40	3.21	8.88	2.53	3.51	9.71	2.55	3.81	10.23	2.51	4.07	12.27	2.83	4.34		
43	5.09	2.28	2.23	5.39	2.25	2.39	5.64	2.19	2.58	5.86	2.17	2.70	6.73	2.13	3.16	7.56	2.17	3.48	8.15	2.17	3.75	10.04	2.49	4.03		
Normal																										
DB	LWT																									
	5			7			10			11			15			18			20			25				
	CC	PI	EER	CC	PI	EER	CC	PI	EER	CC	PI	EER	CC	PI	EER	CC	PI	EER	CC	PI	EER	CC	PI	EER		
-5	/	/	/	/	/	/	/	/	/	/	/	/	5.50	0.49	11.21	6.40	0.54	11.83	7.15	0.58	12.31	7.59	0.55	13.82		
0	/	/	/	/	/	/	/	/	/	/	/	/	5.33	0.54	9.79	5.90	0.56	10.53	6.33	0.57	11.14	6.75	0.53	12.66		
5	/	/	/	/	/	/	/	/	/	/	/	/	5.11	0.65	7.84	5.32	0.61	8.74	5.41	0.57	9.54	5.88	0.56	10.60		
10	/	/	/	/	/	/	/	/	/	/	4.29	0.52	8.22	5.26	0.55	9.53	5.99	0.57	10.51	6.58	0.58	11.37	7.16	0.64	11.26	
15	/	/	/	/	/	/	4.73	0.76	6.24	5.06	0.77	6.55	6.39	0.82	7.80	7.36	0.86	8.54	8.15	0.89	9.18	8.94	0.92	9.74		
19	4.67	0.89	5.23	5.18	0.95	5.43	5.60	0.98	5.69	5.89	1.00	5.89	7.06	1.05	6.70	8.16	1.14	7.15	9.06	1.21	7.51	10.48	1.23	8.51		
20	4.83	0.95	5.11	5.36	1.01	5.31	5.82	1.05	5.55	6.10	1.07	5.72	7.23	1.13	6.42	8.35	1.23	6.80	9.29	1.31	7.10	10.87	1.32	8.21		
25	5.65	1.26	4.49	6.25	1.34	4.68	6.78	1.38	4.91	7.10	1.41	5.04	8.35	1.50	5.58	9.53	1.59	5.99	10.47	1.66	6.32	12.30	1.71	7.18		
30	6.48	1.64	3.95	7.17	1.74	4.12	7.78	1.80	4.32	8.12	1.83	4.45	9.51	1.92	4.95	10.73	2.04	5.26	11.69	2.12	5.51	13.76	2.26	6.08		
35	6.31	2.01	3.15	8.20	2.52	3.25	8.57	2.16	3.96	8.68	2.13	4.07	9.09	2.05	4.43	9.90	2.18	4.55	11.08	2.18	5.09	13.23	2.39	5.54		
40	5.40	1.92	2.81	5.87	1.90	3.08	6.27	1.86	3.38	6.56	1.90	3.46	7.73	2.04	3.79	8.56	2.06	4.15	9.18	2.06	4.47	11.14	2.28	4.89		
43	4.18	1.80	2.32	4.33	1.74	2.49	4.44	1.66	2.67	4.62	1.65	2.80	5.36	1.61	3.32	6.24	1.68	3.71	6.98	1.72	4.06	7.94	1.80	4.41		
Minimum																										
DB	LWT																									
	5			7			10			11			15			18			20			25				
	CC	PI	EER	CC	PI	EER	CC	PI	EER	CC	PI	EER	CC	PI	EER	CC	PI	EER	CC	PI	EER	CC	PI	EER		
-5	/	/	/	/	/	/	/	/	/	/	/	/	3.56	0.30	11.68	4.11	0.34	12.24	4.61	0.36	12.69	4.93	0.34	14.49		
0	/	/	/	/	/	/	/	/	/	/	/	/	3.46	0.34	10.23	3.80	0.35	10.96	4.09	0.35	11.61	4.39	0.33	13.14		
5	/	/	/	/	/	/	/	/	/	/	/	/	2.75	0.33	8.42	2.86	0.31	9.32	2.93	0.29	10.13	3.17	0.28	11.40		
10	/	/	/	/	/	/	/	/	/	/	2.38	0.26	9.04	2.92	0.28	10.33	3.31	0.29	11.30	3.67	0.30	12.18	3.97	0.33	12.22	
15	/	/	/	/	/	/	2.90	0.44	6.62	3.00	0.43	6.96	3.42	0.41	8.33	3.77	0.41	9.28	4.08	0.40	10.14	5.11	0.47	10.81		
19	2.39	0.44	5.45	2.45	0.43	5.65	2.62	0.44	5.96	2.80	0.45	6.19	3.56	0.50	7.11	4.26	0.56	7.60	4.91	0.61	8.02	5.96	0.65	9.11		
20	2.44	0.46	5.31	2.50	0.45	5.52	2.55	0.44	5.79	2.75	0.46	5.99	3.59	0.53	6.81	4.38	0.61	7.18	5.11	0.68	7.49	6.17	0.71	8.68		
25	2.71	0.59	4.60	2.77	0.57	4.85	2.81	0.55	5.15	3.04	0.57	5.30	3.95	0.67	5.88	4.76	0.76	6.28	5.52	0.83	6.64	6.69	0.89	7.54		
30	3.08	0.76	4.03	3.15	0.74	4.26	3.19	0.70	4.53	3.44	0.74	4.66	4.45	0.86	5.19	5.31	0.96	5.53	6.10	1.05	5.82	7.41	1.18	6.30		
35	2.88	0.85	3.37	3.26	0.87	3.76	3.61	0.86	4.19	3.80	0.88	4.32	4.55	0.94	4.86	5.26	1.01	5.21	5.90	1.07	5.52	7.28	1.23	5.93		
40	2.44	0.87	2.80	2.70	0.86	3.12	2.94	0.84	3.48	3.11	0.87	3.57	3.79	0.97	3.93	4.38	1.02	4.30	4.91	1.06	4.64	6.34	1.28	4.97		
43	1.43	0.60	2.37	1.78	0.70	2.55	2.12	0.77	2.76	2.26	0.78	2.90	2.80	0.81	3.46	3.20	0.83	3.84	3.55	0.85	4.18	5.06	1.11	4.58		

Abbreviations:

LWT: Leaving water temperature (°C)

DB: Dry-bulb temperature for Outdoor air temperature (°C)

CC: Total cooling capacity (kW)

PI: Power input (kW)

Table 2-4.10: KHC-12RY3-B cooling capacity

Maximum																										
DB	LWT																									
	5			7			10			11			15			18			20			25				
	CC	PI	EER	CC	PI	EER	CC	PI	EER	CC	PI	EER	CC	PI	EER	CC	PI	EER	CC	PI	EER	CC	PI	EER	CC	PI
-5	/	/	/	/	/	/	/	/	/	/	/	/	/	9.55	1.27	7.50	10.05	1.34	7.48	10.39	1.41	7.37	11.39	1.36	8.35	
0	/	/	/	/	/	/	/	/	/	/	/	/	/	9.33	1.57	5.93	10.20	1.53	6.66	10.90	1.49	7.32	11.89	1.50	7.92	
5	/	/	/	/	/	/	/	/	/	/	/	/	/	9.12	1.71	5.32	10.35	1.63	6.33	11.41	1.57	7.27	12.38	1.64	7.57	
10	/	/	/	/	/	/	/	/	/	9.13	2.19	4.17	10.81	2.05	5.27	12.07	1.98	6.10	13.14	1.92	6.85	14.18	1.94	7.32		
15	/	/	/	/	/	/	10.51	2.32	4.53	10.91	2.32	4.69	12.50	2.33	5.36	13.79	2.30	6.00	14.87	2.27	6.56	15.98	2.24	7.14		
19	7.32	1.87	3.92	9.69	2.41	4.01	11.82	2.83	4.19	12.23	2.85	4.29	13.83	2.94	4.70	14.89	2.94	5.07	15.72	2.92	5.37	16.42	2.70	6.09		
20	7.78	2.03	3.83	10.09	2.56	3.94	12.15	2.96	4.10	12.55	3.00	4.19	14.16	3.12	4.54	15.17	3.14	4.84	15.93	3.14	5.08	16.53	2.84	5.82		
25	10.10	3.00	3.37	12.09	3.38	3.57	13.80	3.61	3.82	14.20	3.67	3.87	15.82	3.91	4.04	16.54	3.97	4.17	17.00	4.01	4.24	17.07	3.44	4.96		
30	9.99	3.58	2.79	11.88	3.96	3.00	13.43	4.13	3.25	13.78	4.14	3.33	15.18	4.17	3.64	15.80	4.17	3.79	16.17	4.15	3.90	16.11	3.74	4.31		
35	9.89	4.33	2.29	11.81	4.38	2.70	13.07	4.72	2.77	13.36	4.62	2.89	14.53	4.29	3.39	15.05	4.22	3.57	15.34	4.14	3.71	15.26	3.86	3.95		
40	8.11	4.53	1.79	9.10	4.50	2.02	9.87	4.33	2.28	10.03	4.24	2.37	10.67	3.92	2.72	11.52	4.00	2.88	12.19	4.05	3.01	13.23	3.77	3.51		
43	5.20	3.72	1.40	5.72	3.52	1.63	6.11	3.26	1.87	6.35	3.20	1.98	7.33	3.02	2.43	7.99	3.11	2.57	8.53	3.19	2.67	10.68	3.26	3.27		
Normal																										
DB	LWT																									
	5			7			10			11			15			18			20			25				
	CC	PI	EER	CC	PI	EER	CC	PI	EER	CC	PI	EER	CC	PI	EER	CC	PI	EER	CC	PI	EER	CC	PI	EER	CC	PI
-5	/	/	/	/	/	/	/	/	/	/	/	/	7.69	0.91	8.47	8.11	0.95	8.54	8.46	0.99	8.51	9.25	0.97	9.52		
0	/	/	/	/	/	/	/	/	/	/	/	/	7.53	1.11	6.78	8.25	1.07	7.68	8.89	1.05	8.48	9.67	1.05	9.22		
5	/	/	/	/	/	/	/	/	/	/	/	/	7.30	1.26	5.80	8.27	1.18	6.99	9.16	1.13	8.10	10.05	1.21	8.32		
10	/	/	/	/	/	/	/	/	/	7.36	1.66	4.43	8.68	1.51	5.75	9.68	1.44	6.74	10.57	1.38	7.65	11.54	1.43	8.07		
15	/	/	/	/	/	/	7.88	1.62	4.86	8.41	1.66	5.06	10.50	1.80	5.82	11.70	1.76	6.63	12.78	1.74	7.36	13.43	1.67	8.05		
19	5.68	1.38	4.12	7.67	1.78	4.30	9.44	2.08	4.54	9.86	2.11	4.67	11.54	2.24	5.16	12.60	2.25	5.59	13.53	2.27	5.96	14.20	2.07	6.86		
20	6.07	1.51	4.02	8.01	1.90	4.23	9.83	2.20	4.46	10.22	2.24	4.57	11.81	2.36	4.99	12.82	2.40	5.33	13.71	2.44	5.61	14.39	2.19	6.56		
25	8.00	2.24	3.56	9.74	2.53	3.85	11.33	2.71	4.17	11.74	2.78	4.22	13.39	3.04	4.41	14.19	3.09	4.60	14.84	3.14	4.73	15.07	2.65	5.68		
30	8.04	2.71	2.97	9.69	3.00	3.23	11.19	3.18	3.52	11.56	3.20	3.61	13.03	3.27	3.99	13.74	3.30	4.16	14.31	3.34	4.28	14.43	2.97	4.86		
35	8.98	3.75	2.40	11.50	4.18	2.75	12.13	4.25	2.85	12.10	4.02	3.01	11.97	3.28	3.65	12.00	3.04	3.95	13.39	3.38	3.96	13.91	3.18	4.37		
40	6.62	3.45	1.92	7.54	3.43	2.20	8.35	3.35	2.49	8.53	3.29	2.59	9.28	3.09	3.00	10.16	3.17	3.21	10.94	3.24	3.38	12.00	2.97	4.05		
43	4.27	2.93	1.45	4.57	2.68	1.70	4.80	2.44	1.97	5.01	2.39	2.10	5.83	2.23	2.61	6.60	2.36	2.80	7.30	2.47	2.96	8.44	2.30	3.66		
Minimum																										
DB	LWT																									
	5			7			10			11			15			18			20			25				
	CC	PI	EER	CC	PI	EER	CC	PI	EER	CC	PI	EER	CC	PI	EER	CC	PI	EER	CC	PI	EER	CC	PI	EER	CC	PI
-5	/	/	/	/	/	/	/	/	/	/	/	/	4.98	0.56	8.83	5.23	0.59	8.84	5.46	0.62	8.78	6.00	0.60	9.98		
0	/	/	/	/	/	/	/	/	/	/	/	/	4.88	0.69	7.09	5.33	0.67	8.00	5.75	0.65	8.84	6.29	0.66	9.56		
5	/	/	/	/	/	/	/	/	/	/	/	/	3.93	0.63	6.23	4.46	0.60	7.45	4.96	0.58	8.61	5.41	0.60	8.95		
10	/	/	/	/	/	/	/	/	/	4.07	0.83	4.89	4.81	0.77	6.24	5.37	0.74	7.25	5.91	0.72	8.20	6.40	0.73	8.75		
15	/	/	/	/	/	/	4.83	0.94	5.16	4.99	0.93	5.37	5.63	0.91	6.22	6.02	0.84	7.19	6.39	0.79	8.11	7.67	0.86	8.92		
19	2.91	0.68	4.29	3.58	0.80	4.47	4.41	0.93	4.75	4.69	0.96	4.90	5.82	1.06	5.47	6.58	1.11	5.94	7.32	1.15	6.35	8.07	1.10	7.33		
20	3.07	0.73	4.18	3.70	0.84	4.39	4.30	0.92	4.65	4.61	0.97	4.78	5.86	1.11	5.29	6.72	1.20	5.62	7.55	1.28	5.92	8.16	1.18	6.93		
25	3.84	1.05	3.65	4.28	1.07	3.99	4.69	1.07	4.38	5.02	1.13	4.43	6.33	1.36	4.64	7.09	1.47	4.82	7.82	1.58	4.96	8.19	1.38	5.95		
30	3.82	1.26	3.03	4.22	1.27	3.34	4.59	1.25	3.68	4.89	1.29	3.78	6.10	1.46	4.17	6.80	1.56	4.36	7.47	1.65	4.51	7.77	1.54	5.04		
35	3.50	1.42	2.46	4.26	1.50	2.83	4.98	1.64	3.04	5.18	1.61	3.21	5.99	1.53	3.90	6.57	1.56	4.21	7.13	1.64	4.36	7.66	1.65	4.65		
40	2.99	1.56	1.91	3.46	1.56	2.22	3.91	1.53	2.56	4.04	1.51	2.67	4.55	1.46	3.11	5.21	1.57	3.32	5.85	1.67	3.50	6.83	1.66	4.12		
43	1.46	0.98	1.48	1.89	1.08	1.75	2.30	1.13	2.03	2.45	1.13	2.17	3.05	1.12	2.72	3.39	1.17	2.89	3.72	1.22	3.04	5.38	1.42	3.80		

Abbreviations:
 LWT: Leaving water temperature (°C)
 DB: Dry-bulb temperature for Outdoor air temperature (°C)
 CC: Total cooling capacity (kW)
 PI: Power input (kW)

Table 2-4.11: KHC-14RY3-B cooling capacity

Maximum																										
DB	LWT																									
	5			7			10			11			15			18			20			25				
	CC	PI	EER	CC	PI	EER	CC	PI	EER	CC	PI	EER	CC	PI	EER	CC	PI	EER	CC	PI	EER	CC	PI	EER		
-5	/	/	/	/	/	/	/	/	/	/	/	/	10.03	1.32	7.57	10.55	1.40	7.55	10.91	1.47	7.44	11.96	1.42	8.43		
0	/	/	/	/	/	/	/	/	/	/	/	/	9.80	1.67	5.87	10.71	1.62	6.59	11.45	1.58	7.24	12.48	1.59	7.84		
5	/	/	/	/	/	/	/	/	/	/	/	/	9.57	1.76	5.44	10.86	1.68	6.47	11.98	1.61	7.43	13.00	1.68	7.73		
10	/	/	/	/	/	/	/	/	/	/	/	10.02	2.46	4.07	11.35	2.18	5.21	12.34	2.03	6.07	13.14	1.92	6.85	14.18	1.94	7.32
15	/	/	/	/	/	/	/	/	10.98	2.32	4.60	11.40	2.39	4.77	13.06	2.32	5.45	14.41	2.36	6.10	15.53	2.32	6.67	16.38	2.32	7.26
19	7.69	1.99	3.86	10.37	2.63	3.95	12.40	2.99	4.15	12.83	3.02	4.25	14.51	3.11	4.67	15.30	3.02	5.06	15.85	2.94	5.40	16.50	2.70	6.11		
20	8.17	2.17	3.77	10.80	2.78	3.88	12.76	3.16	4.04	13.18	3.20	4.12	14.87	3.33	4.47	15.52	3.23	4.80	15.93	3.14	5.08	16.53	2.84	5.82		
25	10.61	3.19	3.32	12.95	3.67	3.53	14.49	3.84	3.77	14.91	3.91	3.82	16.62	4.16	3.99	16.94	4.09	4.14	17.00	4.01	4.24	17.07	3.44	4.96		
30	10.49	3.96	2.65	12.79	4.47	2.86	14.10	4.53	3.11	14.47	4.54	3.19	15.94	4.56	3.49	16.18	4.37	3.70	16.17	4.18	3.87	16.11	3.74	4.31		
35	10.38	4.81	2.16	12.84	5.45	2.35	13.72	5.32	2.58	14.03	5.22	2.69	15.26	4.88	3.13	15.42	4.66	3.31	15.34	4.44	3.45	15.26	4.12	3.71		
40	8.11	4.53	1.79	9.28	4.59	2.02	9.87	4.33	2.28	10.03	4.24	2.37	10.67	3.92	2.72	11.52	4.00	2.88	12.19	4.05	3.01	13.23	3.77	3.51		
43	5.20	3.72	1.40	5.83	3.59	1.63	6.11	3.26	1.87	6.35	3.20	1.98	7.33	3.02	2.43	7.99	3.11	2.57	8.53	3.19	2.67	10.68	3.26	3.27		
Normal																										
DB	LWT																									
	5			7			10			11			15			18			20			25				
	CC	PI	EER	CC	PI	EER	CC	PI	EER	CC	PI	EER	CC	PI	EER	CC	PI	EER	CC	PI	EER	CC	PI	EER		
-5	/	/	/	/	/	/	/	/	/	/	/	/	8.07	0.94	8.56	8.52	0.99	8.63	8.88	1.03	8.60	9.72	1.01	9.61		
0	/	/	/	/	/	/	/	/	/	/	/	/	7.90	1.18	6.71	8.66	1.14	7.60	9.33	1.11	8.39	10.16	1.11	9.13		
5	/	/	/	/	/	/	/	/	/	/	/	/	7.67	1.29	5.93	8.68	1.21	7.15	9.61	1.16	8.28	10.55	1.24	8.50		
10	/	/	/	/	/	/	/	/	/	8.08	1.87	4.32	9.12	1.60	5.69	9.90	1.48	6.71	10.57	1.38	7.65	11.54	1.43	8.07		
15	/	/	/	/	/	/	8.24	1.67	4.94	8.78	1.71	5.14	10.97	1.85	5.92	12.23	1.81	6.74	13.36	1.79	7.48	13.76	1.68	8.19		
19	5.97	1.47	4.05	8.21	1.94	4.24	9.90	2.20	4.50	10.34	2.24	4.63	12.11	2.37	5.12	12.94	2.32	5.59	13.64	2.28	5.99	14.26	2.07	6.88		
20	6.37	1.61	3.96	8.58	2.06	4.16	10.32	2.35	4.40	10.73	2.39	4.50	12.40	2.52	4.92	13.12	2.48	5.30	13.71	2.44	5.61	14.39	2.19	6.56		
25	8.40	2.39	3.52	10.43	2.74	3.80	11.89	2.89	4.12	12.33	2.96	4.17	14.06	3.23	4.35	14.52	3.18	4.57	14.84	3.14	4.73	15.07	2.65	5.68		
30	8.44	2.99	2.82	10.38	3.37	3.08	11.75	3.49	3.37	12.14	3.51	3.46	13.68	3.57	3.83	14.07	3.46	4.06	14.31	3.37	4.25	14.43	2.97	4.86		
35	8.07	3.56	2.27	12.40	4.96	2.50	12.86	4.75	2.71	12.92	4.54	2.85	13.17	3.87	3.40	13.50	3.74	3.61	13.59	3.58	3.80	13.91	3.35	4.15		
40	6.62	3.45	1.92	7.69	3.50	2.20	8.35	3.35	2.49	8.53	3.29	2.59	9.28	3.09	3.00	10.16	3.17	3.21	10.94	3.24	3.38	12.00	2.97	4.05		
43	4.27	2.93	1.45	4.66	2.73	1.70	4.80	2.44	1.97	5.01	2.39	2.10	5.83	2.23	2.61	6.60	2.36	2.80	7.30	2.47	2.96	8.44	2.30	3.66		
Minimum																										
DB	LWT																									
	5			7			10			11			15			18			20			25				
	CC	PI	EER	CC	PI	EER	CC	PI	EER	CC	PI	EER	CC	PI	EER	CC	PI	EER	CC	PI	EER	CC	PI	EER		
-5	/	/	/	/	/	/	/	/	/	/	/	/	5.22	0.59	8.92	5.49	0.61	8.93	5.73	0.65	8.86	6.30	0.63	10.08		
0	/	/	/	/	/	/	/	/	/	/	/	/	5.13	0.73	7.01	5.59	0.71	7.92	6.04	0.69	8.75	6.61	0.70	9.47		
5	/	/	/	/	/	/	/	/	/	/	/	/	4.12	0.65	6.37	4.68	0.61	7.61	5.21	0.59	8.80	5.68	0.62	9.15		
10	/	/	/	/	/	/	/	/	/	4.47	0.94	4.77	5.06	0.82	6.16	5.49	0.76	7.21	5.91	0.72	8.20	6.40	0.73	8.75		
15	/	/	/	/	/	/	5.05	0.96	5.24	5.22	0.96	5.46	5.88	0.93	6.32	6.29	0.86	7.31	6.68	0.81	8.25	7.86	0.87	9.07		
19	3.06	0.72	4.22	3.79	0.86	4.40	4.62	0.98	4.71	4.92	1.01	4.86	6.10	1.12	5.43	6.75	1.14	5.93	7.38	1.16	6.38	8.10	1.10	7.36		
20	3.22	0.78	4.12	3.92	0.91	4.32	4.52	0.99	4.58	4.85	1.03	4.71	6.16	1.18	5.21	6.87	1.23	5.58	7.55	1.28	5.92	8.16	1.18	6.93		
25	4.03	1.12	3.60	4.53	1.15	3.94	4.93	1.14	4.32	5.27	1.21	4.37	6.65	1.45	4.58	7.25	1.51	4.79	7.82	1.58	4.96	8.19	1.38	5.95		
30	4.01	1.39	2.88	4.47	1.40	3.18	4.82	1.37	3.53	5.14	1.42	3.62	6.41	1.60	4.01	6.95	1.63	4.26	7.47	1.67	4.48	7.77	1.54	5.04		
35	3.67	1.58	2.33	4.50	1.68	2.68	5.23	1.78	2.94	5.44	1.76	3.09	6.29	1.70	3.69	6.72	1.60	4.21	7.13	1.73	4.11	7.66	1.73	4.44		
40	2.99	1.56	1.91	3.49	1.57	2.22	3.91	1.53	2.56	4.04	1.51	2.67	4.55	1.46	3.11	5.21	1.57	3.32	5.85	1.67	3.50	6.83	1.66	4.12		
43	1.46	0.98	1.48	1.90	1.09	1.75	2.30	1.13	2.03	2.45	1.13	2.17	3.05	1.12	2.72	3.39	1.17	2.89	3.72	1.22	3.04	5.38	1.42	3.80		

Abbreviations:

LWT: Leaving water temperature (°C)

DB: Dry-bulb temperature for Outdoor air temperature (°C)

CC: Total cooling capacity (kW)

PI: Power input (kW)

Table 2-4.12: KHC-16RY3-B cooling capacity

Maximum																										
DB	LWT																									
	5			7			10			11			15			18			20			25				
	CC	PI	EER	CC	PI	EER	CC	PI	EER	CC	PI	EER	CC	PI	EER	CC	PI	EER	CC	PI	EER	CC	PI	EER		
-5	/	/	/	/	/	/	/	/	/	/	/	/	/	10.03	1.32	7.57	10.55	1.40	7.55	10.91	1.47	7.44	11.96	1.42	8.43	
0	/	/	/	/	/	/	/	/	/	/	/	/	/	9.80	1.67	5.87	10.71	1.62	6.59	11.45	1.58	7.24	12.48	1.59	7.84	
5	/	/	/	/	/	/	/	/	/	/	/	/	/	9.57	1.76	5.44	10.86	1.68	6.47	11.98	1.61	7.43	13.00	1.68	7.73	
10	/	/	/	/	/	/	/	/	/	10.02	2.46	4.07	11.35	2.18	5.21	12.34	2.03	6.07	13.14	1.92	6.85	14.18	1.94	7.32		
15	/	/	/	/	/	/	11.37	2.43	4.67	11.80	2.44	4.84	13.52	2.44	5.53	14.92	2.41	6.19	16.08	2.37	6.77	16.96	2.30	7.37		
19	8.46	2.23	3.78	11.41	2.94	3.87	13.50	3.29	4.10	13.86	3.29	4.21	15.31	3.30	4.65	16.15	3.20	5.04	16.73	3.11	5.38	17.41	2.86	6.08		
20	8.99	2.43	3.70	11.88	3.12	3.80	14.04	3.55	3.96	14.38	3.55	4.05	15.76	3.56	4.42	16.46	3.46	4.75	16.89	3.36	5.03	17.52	3.04	5.76		
25	11.67	3.59	3.25	14.24	4.13	3.45	15.94	4.32	3.69	16.24	4.36	3.73	17.45	4.47	3.90	17.72	4.38	4.04	17.85	4.31	4.14	17.92	3.70	4.84		
30	11.54	4.46	2.59	14.26	5.10	2.79	15.51	5.11	3.04	15.85	5.09	3.11	17.21	5.05	3.41	17.24	4.84	3.57	17.14	4.66	3.68	16.92	4.02	4.21		
35	11.42	5.42	2.11	14.18	6.17	2.30	15.09	6.00	2.52	15.37	5.91	2.60	16.48	5.60	2.94	16.50	5.28	3.13	16.26	4.96	3.27	16.17	4.47	3.62		
40	8.92	5.11	1.75	10.21	5.18	1.97	10.86	4.89	2.22	11.03	4.78	2.31	11.73	4.42	2.65	12.67	4.57	2.77	13.41	4.69	2.86	14.55	4.36	3.34		
43	5.98	4.50	1.33	6.87	4.44	1.54	7.33	4.12	1.78	7.67	4.07	1.89	9.01	3.91	2.31	9.83	4.03	2.44	10.49	4.13	2.54	11.96	3.85	3.11		
Normal																										
DB	LWT																									
	5			7			10			11			15			18			20			25				
	CC	PI	EER	CC	PI	EER	CC	PI	EER	CC	PI	EER	CC	PI	EER	CC	PI	EER	CC	PI	EER	CC	PI	EER	CC	PI
-5	/	/	/	/	/	/	/	/	/	/	/	/	/	8.07	0.94	8.56	8.52	0.99	8.63	8.88	1.03	8.60	9.72	1.01	9.61	
0	/	/	/	/	/	/	/	/	/	/	/	/	/	7.90	1.18	6.71	8.66	1.14	7.60	9.33	1.11	8.39	10.16	1.11	9.13	
5	/	/	/	/	/	/	/	/	/	/	/	/	/	7.67	1.29	5.93	8.68	1.21	7.15	9.61	1.16	8.28	10.55	1.24	8.50	
10	/	/	/	/	/	/	/	/	/	8.08	1.87	4.32	9.12	1.60	5.69	9.90	1.48	6.71	10.57	1.38	7.65	11.54	1.43	8.07		
15	/	/	/	/	/	/	8.52	1.70	5.02	9.09	1.74	5.22	11.36	1.89	6.01	12.65	1.85	6.84	13.83	1.82	7.59	14.24	1.71	8.31		
19	6.56	1.65	3.98	9.03	2.17	4.15	10.79	2.42	4.45	11.18	2.44	4.58	12.78	2.51	5.10	13.66	2.45	5.56	14.39	2.41	5.96	15.05	2.20	6.85		
20	7.01	1.80	3.88	9.44	2.31	4.08	11.35	2.63	4.31	11.71	2.65	4.42	13.14	2.70	4.87	13.91	2.65	5.24	14.53	2.62	5.56	15.25	2.35	6.49		
25	9.24	2.69	3.43	11.47	3.09	3.71	13.08	3.25	4.02	13.42	3.30	4.07	14.76	3.47	4.25	15.25	3.42	4.46	15.58	3.37	4.62	15.83	2.85	5.55		
30	9.28	3.37	2.75	11.42	3.79	3.01	12.93	3.93	3.29	13.30	3.94	3.38	14.77	3.95	3.74	15.05	3.85	3.91	15.17	3.75	4.04	15.15	3.19	4.75		
35	9.87	4.46	2.21	14.00	5.60	2.50	14.19	5.23	2.71	14.27	5.10	2.79	14.57	4.65	3.13	14.20	3.94	3.61	15.19	4.33	3.51	15.15	3.93	3.85		
40	7.28	3.89	1.87	8.46	3.95	2.14	9.18	3.78	2.43	9.39	3.71	2.53	10.21	3.49	2.93	11.18	3.62	3.09	12.03	3.75	3.21	13.20	3.43	3.84		
43	4.91	3.55	1.38	5.48	3.39	1.62	5.76	3.08	1.87	6.04	3.03	1.99	7.17	2.89	2.48	8.12	3.05	2.66	8.98	3.20	2.81	9.46	2.72	3.48		
Minimum																										
DB	LWT																									
	5			7			10			11			15			18			20			25				
	CC	PI	EER	CC	PI	EER	CC	PI	EER	CC	PI	EER	CC	PI	EER	CC	PI	EER	CC	PI	EER	CC	PI	EER	CC	PI
-5	/	/	/	/	/	/	/	/	/	/	/	/	/	5.22	0.59	8.92	5.49	0.61	8.93	5.73	0.65	8.86	6.30	0.63	10.08	
0	/	/	/	/	/	/	/	/	/	/	/	/	/	5.13	0.73	7.01	5.59	0.71	7.92	6.04	0.69	8.75	6.61	0.70	9.47	
5	/	/	/	/	/	/	/	/	/	/	/	/	/	4.12	0.65	6.37	4.68	0.61	7.61	5.21	0.59	8.80	5.68	0.62	9.15	
10	/	/	/	/	/	/	/	/	/	4.47	0.94	4.77	5.06	0.82	6.16	5.49	0.76	7.21	5.91	0.72	8.20	6.40	0.73	8.75		
15	/	/	/	/	/	/	5.23	0.98	5.32	5.40	0.97	5.54	6.08	0.95	6.41	6.51	0.88	7.42	6.91	0.83	8.37	8.14	0.88	9.21		
19	3.36	0.81	4.14	4.17	0.97	4.32	5.02	1.08	4.66	5.30	1.10	4.81	6.44	1.19	5.41	7.13	1.21	5.91	7.79	1.22	6.36	8.55	1.17	7.33		
20	3.54	0.88	4.04	4.31	1.02	4.24	4.97	1.11	4.49	5.28	1.14	4.62	6.53	1.27	5.15	7.28	1.32	5.53	8.01	1.37	5.86	8.65	1.26	6.86		
25	4.43	1.26	3.52	4.98	1.30	3.85	5.42	1.28	4.22	5.73	1.34	4.27	6.98	1.56	4.47	7.61	1.63	4.68	8.21	1.69	4.85	8.60	1.48	5.81		
30	4.41	1.57	2.81	4.92	1.58	3.11	5.31	1.54	3.44	5.63	1.59	3.54	6.92	1.77	3.91	7.43	1.81	4.10	7.92	1.86	4.26	8.15	1.66	4.92		
35	4.04	1.78	2.27	4.95	1.94	2.56	5.75	2.00	2.87	5.96	1.99	2.99	6.79	1.96	3.47	7.19	1.80	4.00	7.56	1.83	4.12	8.12	1.87	4.33		
40	3.29	1.76	1.86	3.84	1.77	2.17	4.30	1.72	2.50	4.44	1.70	2.60	5.01	1.65	3.03	5.73	1.80	3.19	6.43	1.93	3.33	7.52	1.92	3.91		
43	1.68	1.19	1.41	2.24	1.35	1.66	2.76	1.43	1.93	2.95	1.44	2.06	3.75	1.45	2.58	4.17	1.52	2.75	4.57	1.58	2.89	6.03	1.67	3.61		

Abbreviations:

LWT: Leaving water temperature (°C)

DB: Dry-bulb temperature for Outdoor air temperature (°C)

CC: Total cooling capacity (kW)

PI: Power input (kW)

5 Operating Limits

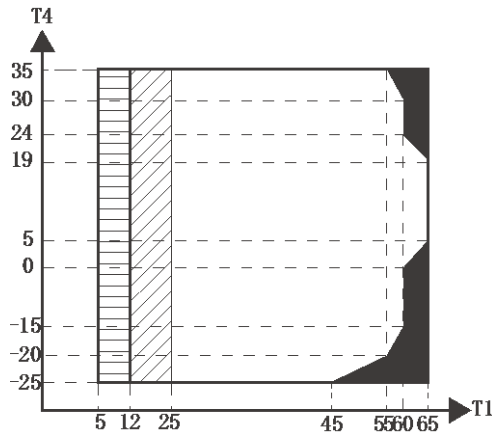

Figure 2-5.1: Heating operating limits¹

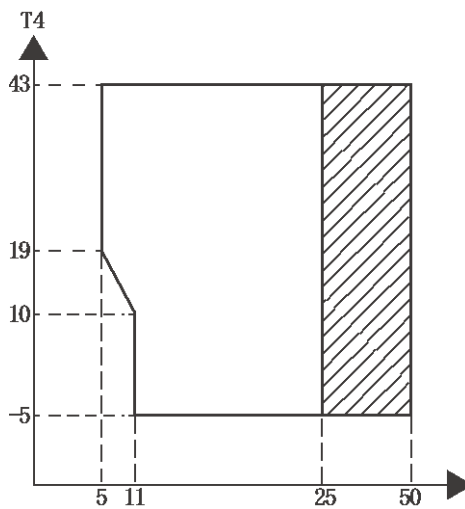

Figure 2-5.2: Cooling operating limits

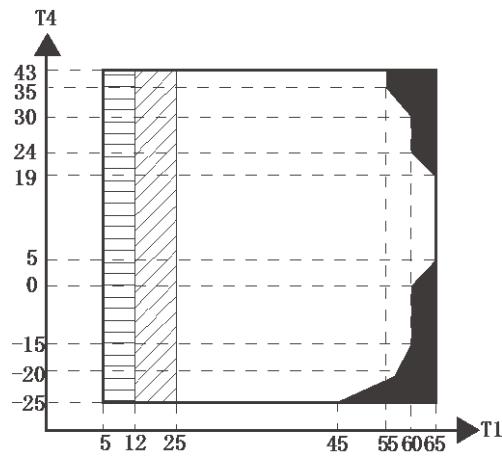

Figure 2-5.3: Domestic hot water operating limits¹

Abbreviations:

- T4: Outdoor temperature(°C)
- T1: Leaving water temperature (°C)
- IBH: Backup electric heater
- AHS: Additional heat source

Notes:

1. IBH/AHS only
2. Water flow temperature drops or rises interval
3. If IBH/AHS setting is valid, only IBH/AHS turns on; If IBH/AHS setting is invalid, only heat pump turns on

6 Hydronic Performance

KHC-06RY1-B, KHC-08RY3-B, KHC-10RY3-B

Figure 2-6.1: KHC-06RY1-B, KHC-08RY3-B, KHC-10RY3-B hydronic performance¹

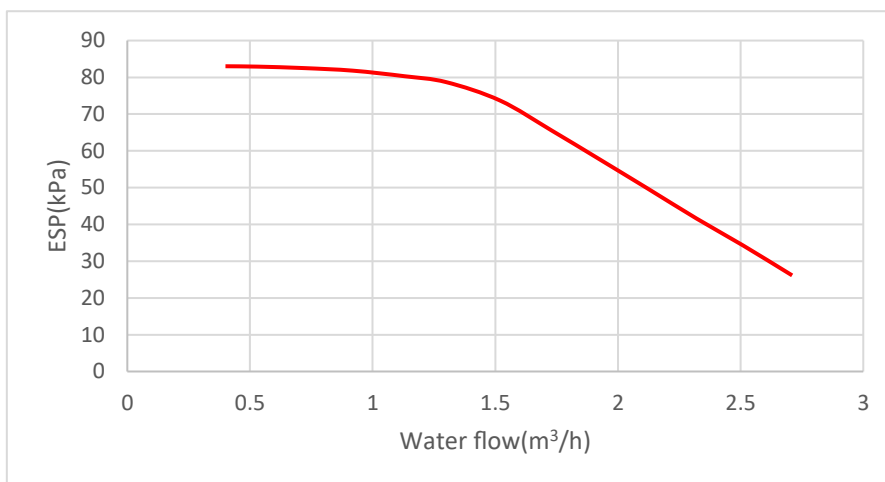

Abbreviations:

ESP: External static pressure

KHC-12RY3-B, KHC-14RY3-B, KHC-16RY3-B

Figure 2-6.2: KHC-12RY3-B, KHC-14RY3-B, KHC-16RY3-B hydronic performance¹

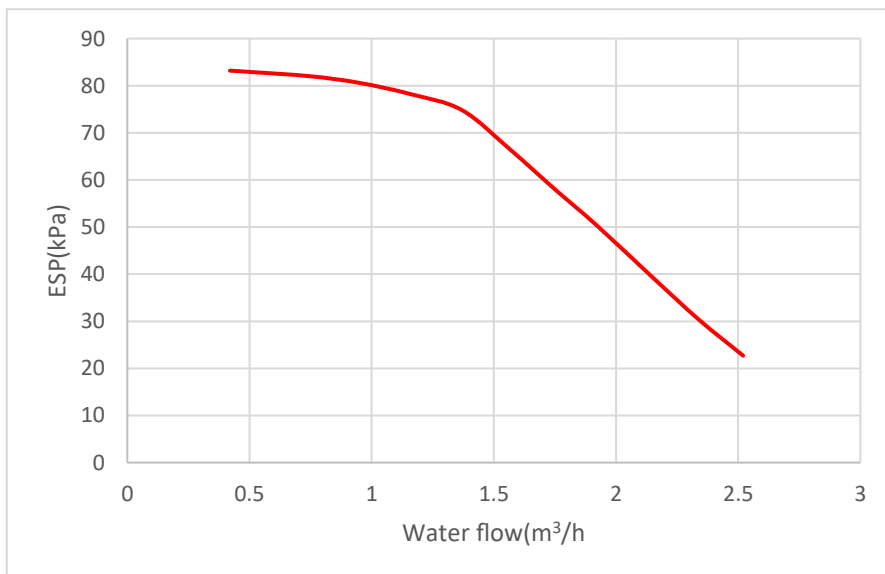

Abbreviations:

ESP: External static pressure

7 Sound Levels

7.1 Overall

Table 2-7.1: Sound pressure levels¹

Model name	dB ²
KHC-06RY1-B	47.5
KHC-08RY3-B	48.5
KHC-10RY3-B	50.5
KHC-12RY3-B	53.5
KHC-14RY3-B	54.0
KHC-16RY3-B	58.0

Notes:

1. Sound pressure level is measured at a position 1m in front of the unit and $(1+H)/2$ m (where H is the height of the unit) above the floor in a semi-anechoic chamber. During in-situ operation, sound pressure levels may be higher as a result of ambient noise.

Figure 2-6.1: Sound pressure level measurement (unit: mm)

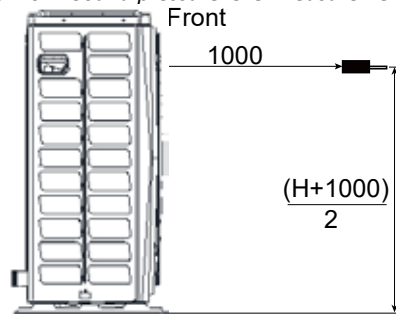

2. dB is the maximum value tested under the conditions below:
 Outdoor air temperature 7°C DB, 85% R.H.; EWT 30°C, LWT 35°C. Free compressor frequency.
 Outdoor air temperature 7°C DB, 85% R.H.; EWT 47°C, LWT 55°C. Free compressor frequency.

7.2 Octave Band Levels

Figure 2-7.2: KHC-06RY1-B octave band levels

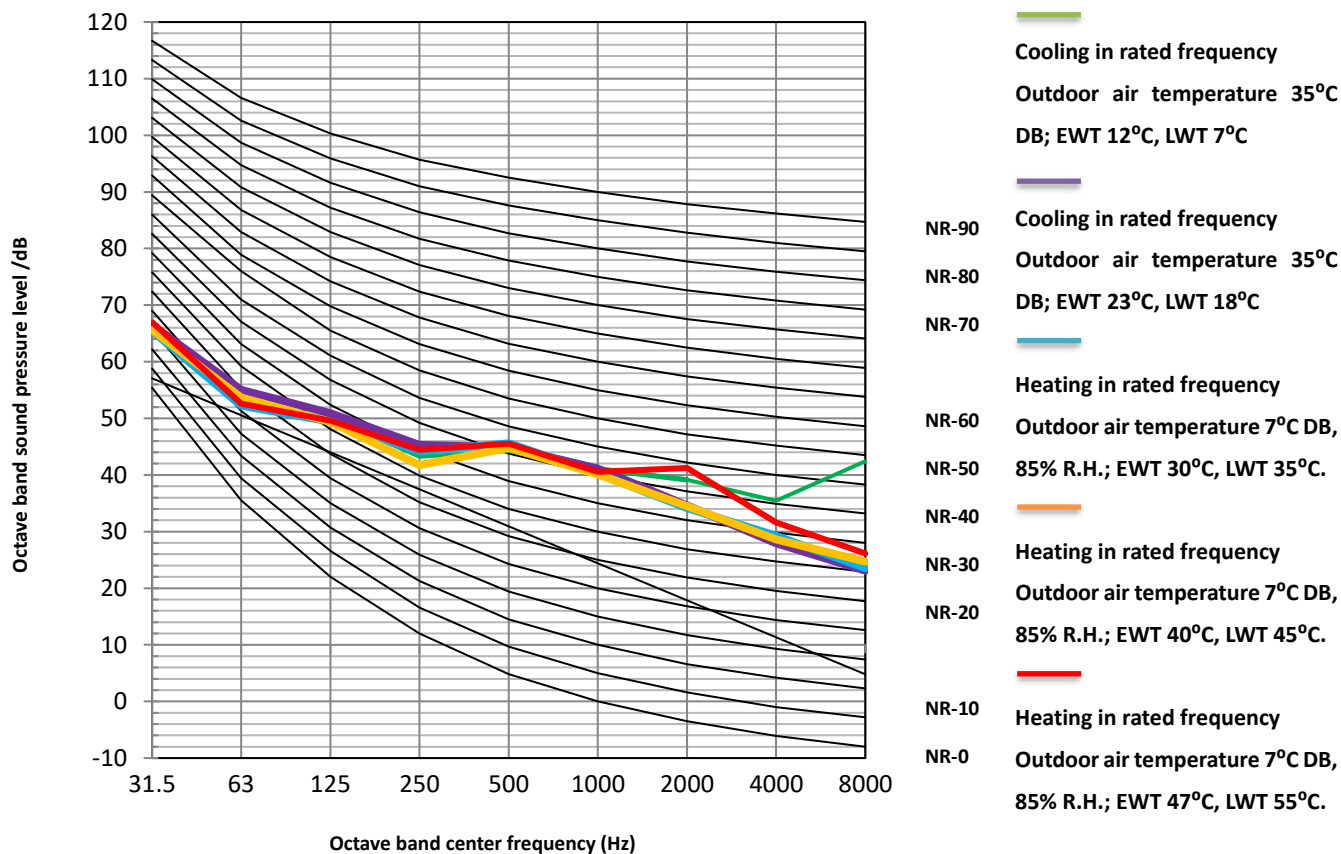

Figure 2-7.3: KHC-08RY3-B octave band levels

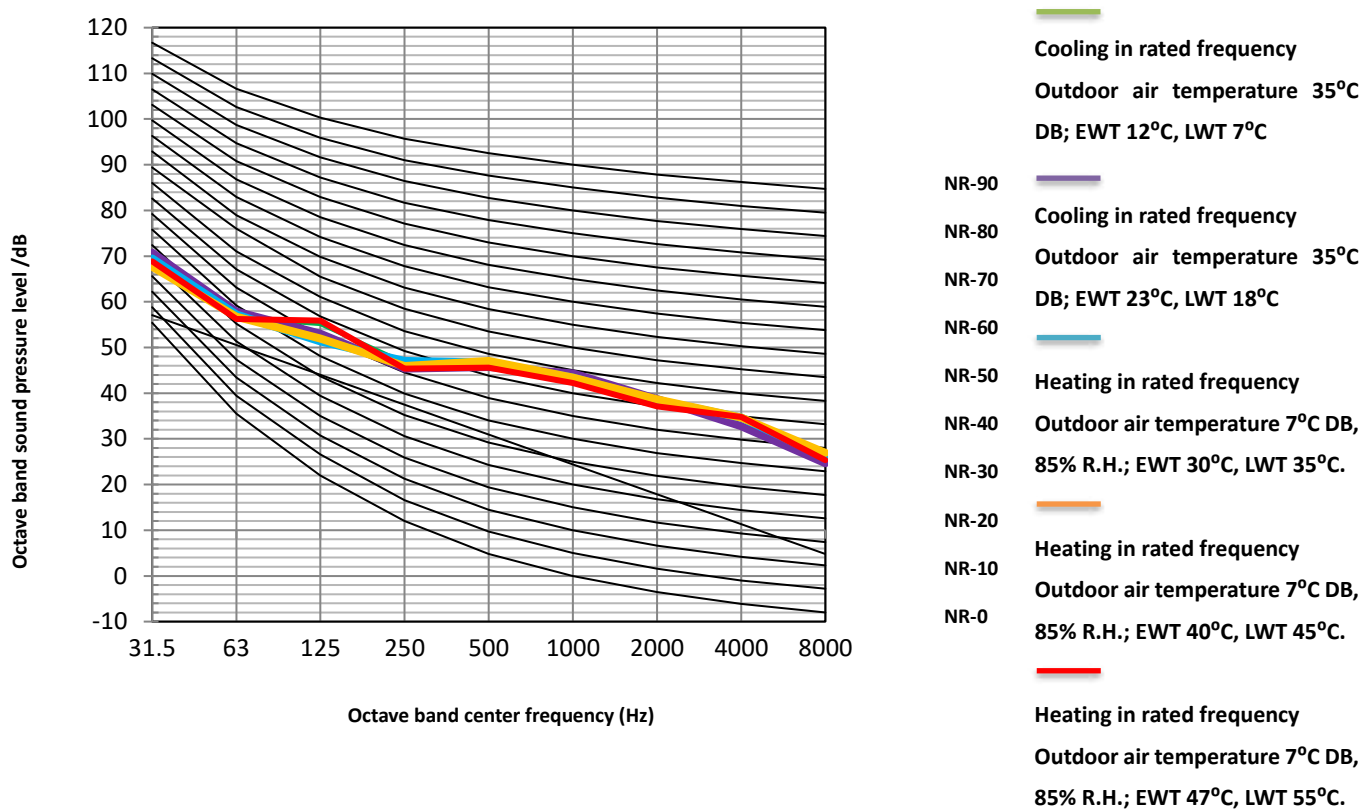
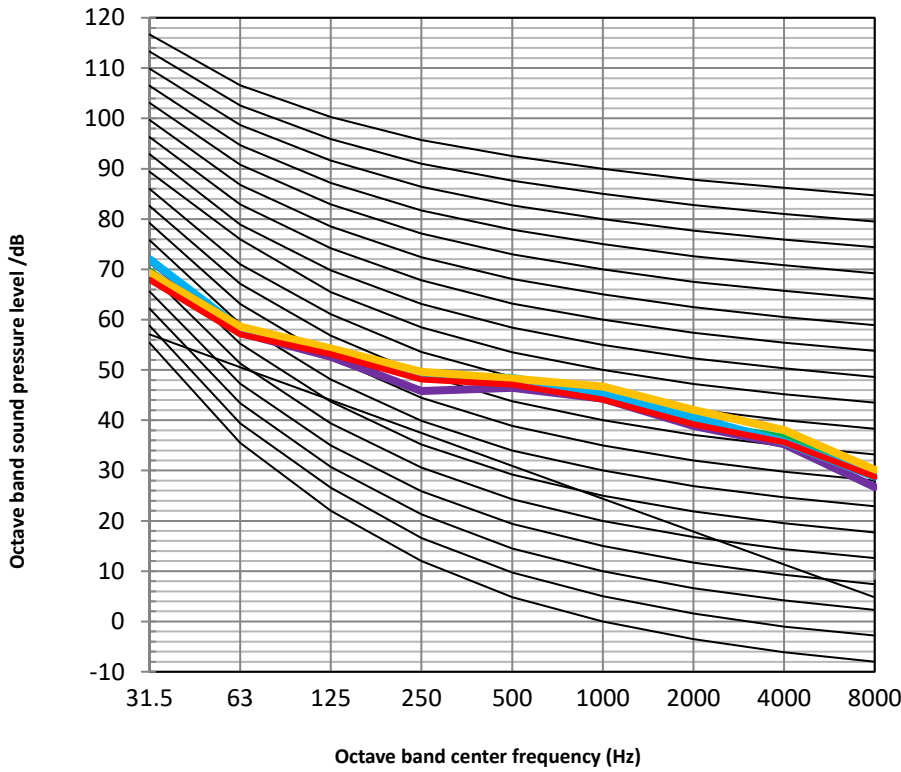
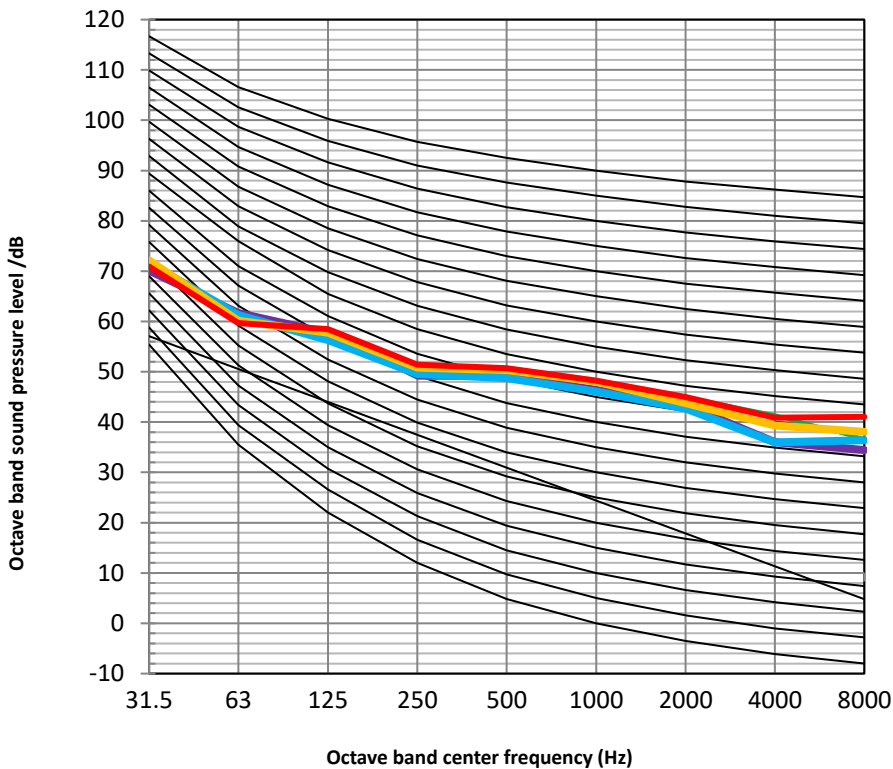

Figure 2-7.4: KHC-10RY3-B octave band levels



- Cooling in rated frequency
Outdoor air temperature 35°C
DB; EWT 12°C, LWT 7°C
- NR-90 Cooling in rated frequency
- NR-80 Outdoor air temperature 35°C
DB; EWT 23°C, LWT 18°C
- NR-60 Heating in rated frequency
- NR-50 Outdoor air temperature 7°C DB,
85% R.H.; EWT 30°C, LWT 35°C.
- NR-30 Heating in rated frequency
- NR-20 Outdoor air temperature 7°C DB,
85% R.H.; EWT 40°C, LWT 45°C.
- NR-10 Heating in rated frequency
- NR-0 Outdoor air temperature 7°C DB,
85% R.H.; EWT 47°C, LWT 55°C.

Figure 2-7.5: KHC-12RY3-B octave band levels



- Cooling in rated frequency
Outdoor air temperature 35°C
DB; EWT 12°C, LWT 7°C
- NR-90 Cooling in rated frequency
- NR-80 Outdoor air temperature 35°C
DB; EWT 23°C, LWT 18°C
- NR-60 Heating in rated frequency
- NR-50 Outdoor air temperature 7°C DB,
85% R.H.; EWT 30°C, LWT 35°C.
- NR-30 Heating in rated frequency
- NR-20 Outdoor air temperature 7°C DB,
85% R.H.; EWT 40°C, LWT 45°C.
- NR-10 Heating in rated frequency
- NR-0 Outdoor air temperature 7°C DB,
85% R.H.; EWT 47°C, LWT 55°C.

Figure 2-7.6: KHC-14RY3-B octave band levels

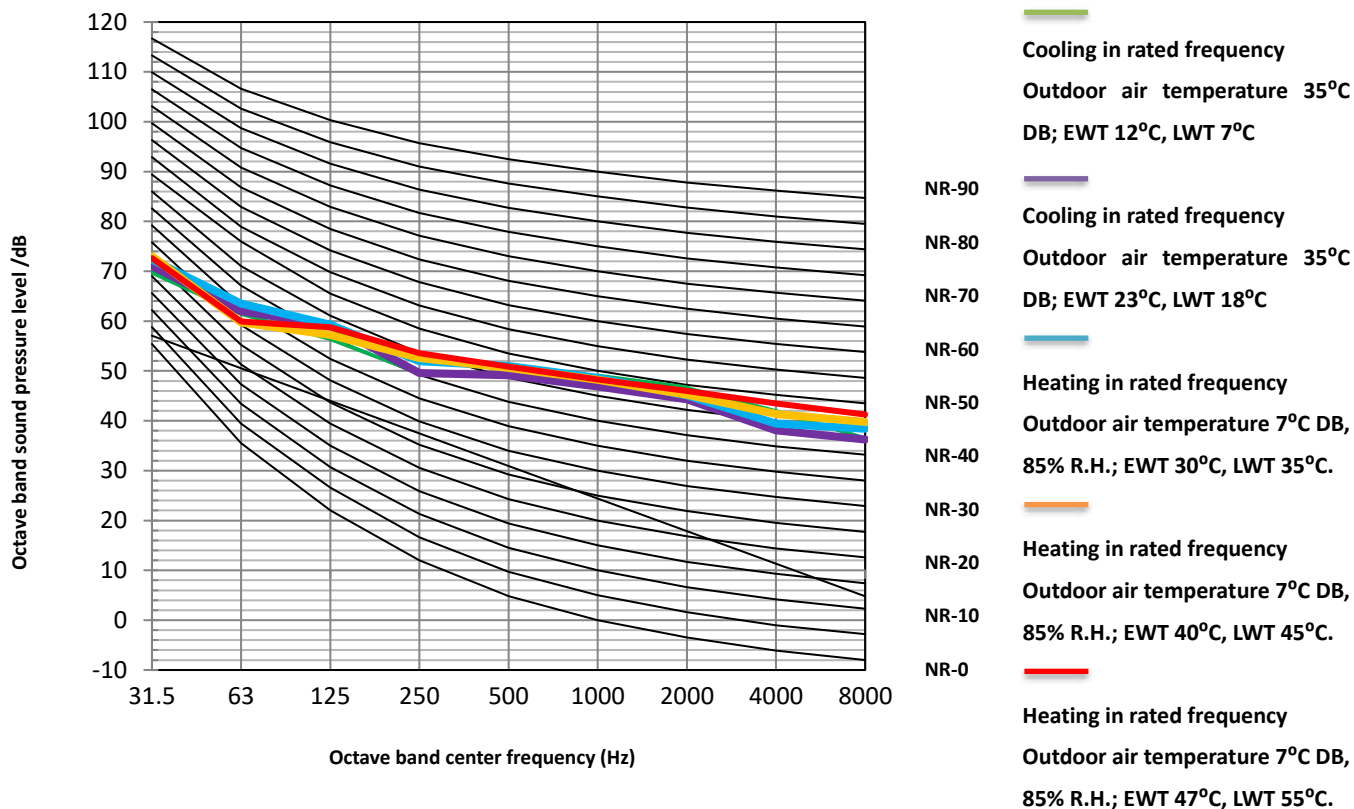
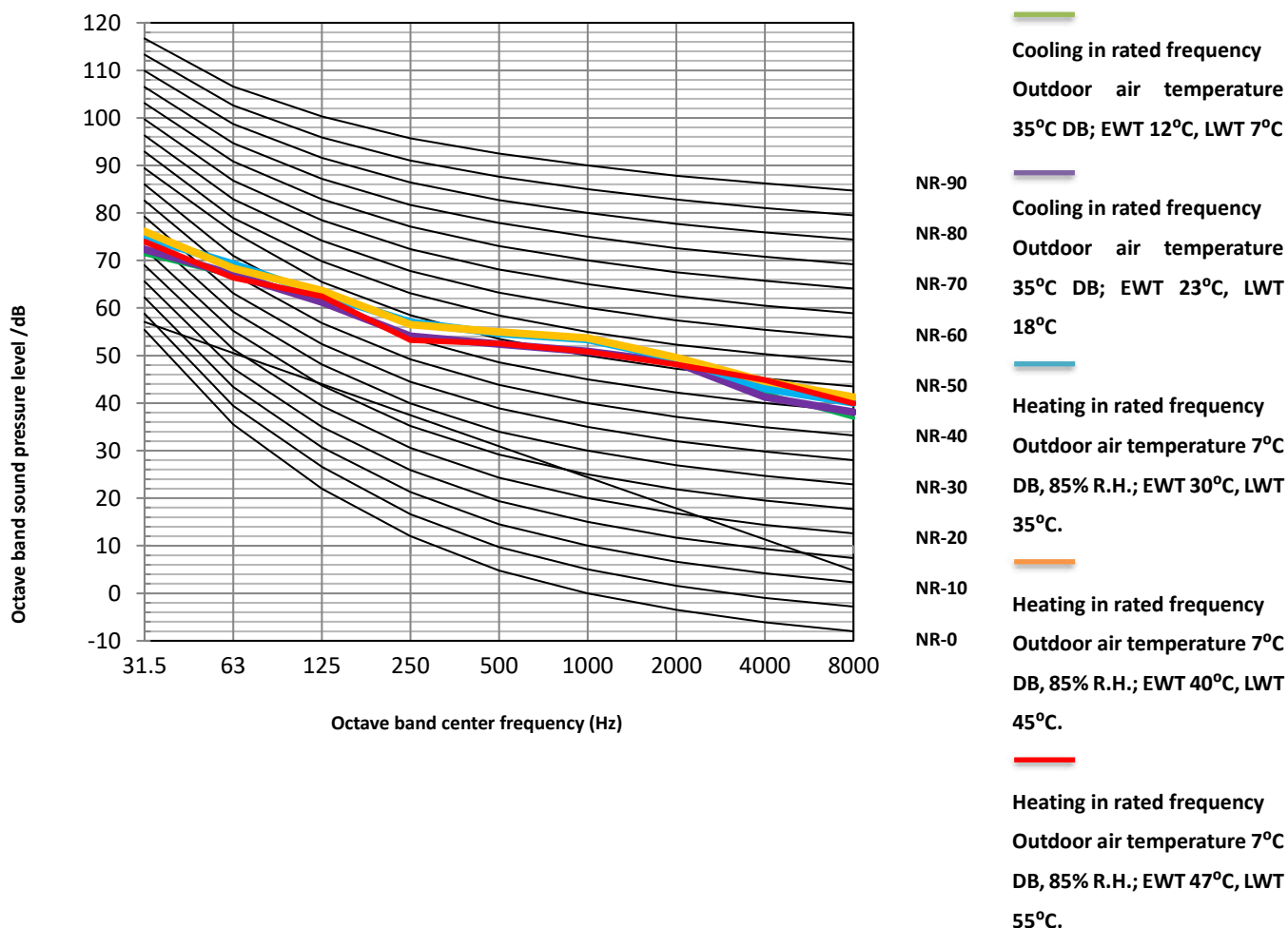













Figure 2-7.7: KHC-16RY3-B octave band levels



8 Accessories







8.1 Standard accessories

Table 2-8.1: Standard accessories

Name	Shape	Quantity	Name	Shape	Quantity
Installation and owner's manual		1	Tighten belt for customer wiring use		2
Operation manual		1	Tighten belt for customer wiring use		3
Technical data manual		1	Thermistor for domestic hot water tank or zone 2 water flow or balance tank		1
Y-shaped filter		1	Network matching wires		1
Drain hose		1	Energy label		1
Wired controller		1			

8.2 Optional accessories

Table 2-8.2: Standard accessories

Name	Shape	Quantity	Name	Shape	Quantity
Thermistor for balance tank(Tbt1)		1	Extension wire for Tbt1		1
Thermistor for Zone 2 flow temp. (Tw2)		1	Extension wire for Tw2		1
Thermistor for solar temp. (Tsolar)		1	Extension wire for Tsolar		1

Part 3

Installation and Field Settings

1 Preface to Part 3.....	56
2 Installation	57
3 Water Pipework	62
4 Electrical Wiring	65
5 DIP Switch Settings.....	68
6 Internal Circulation Pump.....	68
7 User Interface Field Settings	69
8 Operation parameter	88
9 Network Configuration Guidelines.....	89
10 USB function guidelines.....	94
11 Climate Related Curves.....	96
12 Error Code Table	99

1 Preface to Part 3

1.1 Notes for Installers Boxes

The information contained in this Engineering Data Book may primarily be of use during the system design stage of a Mono project. Additional important information which may primarily be of use during field installation has been placed in boxes, such as the example below, titled “Notes for installers”.

Notes for installers



- Notes for installers boxes contain important information which may primarily be of use during field installation, rather than during desk-based system design.

1.2 Definitions

In this Engineering Data Book, the term “applicable legislation” refers to all national, local and other laws, standards, codes, rules, regulations and other legislation that apply in a given situation.

1.3 Precautions

All system installation including installation of water piping and electrical works must only be carried out by competent and suitably qualified, certified and accredited professionals and in accordance with all applicable legislation.

2 Installation

2.1 Acceptance and Unpacking

Notes for installers



- When units are delivered check whether any damage occurred during shipment. If there is damage to the surface or outside of a unit, submit a written report to the shipping company.
- Check that the model, specifications and quantity of the units delivered are as ordered.
- Check that all accessories ordered have been included. Retain the Owner's Manual for future reference.

2.2 Hoisting

Notes for installers



- Do not remove any packaging before hoisting. If units are not packaged or if the packaging is damaged, use suitable boards or packing material to protect the units.
- Hoist one unit at a time, using two ropes to ensure stability.
- Keep units upright during hoisting, ensuring that the angle to the vertical does not exceed 30°.

Figure 3-2.1: Hoisting the unit

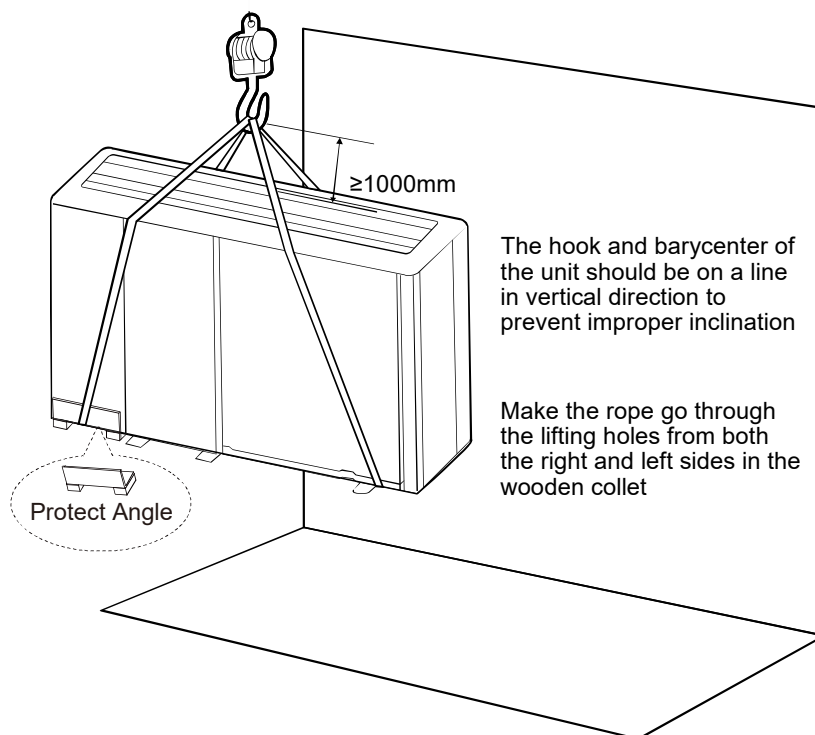

2.3 Placement Considerations

Placement of the outdoor unit should take account of the following considerations:

- Outdoor units should not be exposed to direct radiation from a high-temperature heat source.
- Outdoor units should not be installed in positions where dust or dirt may affect heat exchangers.
- Outdoor units should not be installed in locations where exposure to oil or to corrosive or harmful gases, such as acidic or alkaline gases, may occur.
- Outdoor units should not be installed in locations where exposure to salinity may occur.

Mono

- Outdoor units should be installed in well-drained, well-ventilated positions.
- Outdoor units should be installed in positions that are as close as possible to the heat emitters.
- Outdoor units should be installed in positions that are sufficiently close to the desired position of the wired controller that the controller's wiring length limitation will not be exceeded.
- In systems that are configured to heat domestic hot water and/or include an external backup electric heater, outdoor units should be installed in positions that are sufficiently close to the domestic hot water tank and/or backup electric heater that the temperature sensor wiring length limitations will not be exceeded.
- Outdoor units should be installed in locations where the noise from the unit will not disturb neighbors.

2.4 Strong Wind Installation

Wind of 5m/s or more blowing against an outdoor unit's air outlet blocks the flow of air through the unit, leading to deterioration in unit capacity, accelerated frost accumulation when in heating mode or domestic hot water mode, and potential disruption to operation due to increased pressure in the refrigerant circuit. Exposure to very strong wind can also cause the fan to rotate excessively fast, potentially leading to damage to the fan. In locations where exposure to high winds may occur should take account of the following considerations:

Figure 3-2.2: Strong wind installation direction

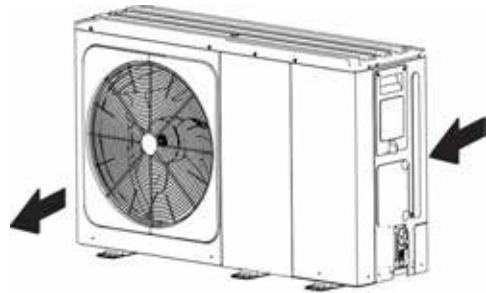

- For installation of the outdoor unit in a place where the wind direction can be foreseen, refer to Figure 3-2.3 and Table 3-2.1 for installation of the unit. Set the outlet side at a right angle to the direction of the wind, refer to Figure 3-2.2.
- If turn the air outlet side toward the building's wall, fence or screen. Make sure there is enough room to do the installation

Figure 3-2.3: Installation room illustration

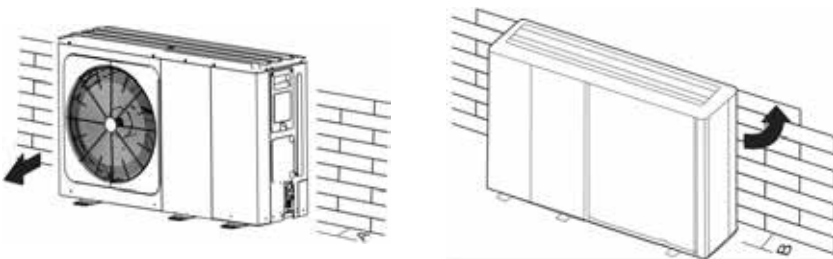

Table 3-2.1: Installation room requirement (Unit: mm)

Model	A(mm)
6kW	≥ 300
8-16KW	≥ 300

Model	B(mm)
6kW	≥ 1000
8-16KW	≥ 1500

2.5 Cold Climate Installation

In cold climate locations installation should take account of the following considerations:

- Never install the unit at a site where the suction side may be exposed directly to wind.
- To prevent exposure to wind, install a baffle plate on the air discharge side of the unit.
- To prevent exposure to wind, install the unit with its suction side facing the wall.
- In areas of heavy snowfall, a canopy should be installed to prevent snow entering the unit. Additionally, the height of the base structure should be increased so as to raise the unit further off the ground. Refer to Figure 3-2.4.

1. Construct a large canopy
2. Construct a pedestal

Install the unit high enough off the ground to prevent it from being buried in snow.

Figure 3-2.4: Snow shielding

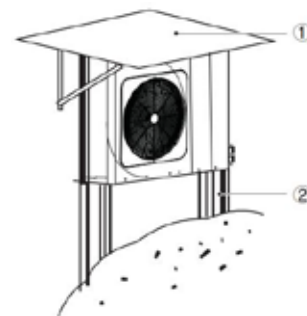

2.6 Hot Climate Installation

As the outdoor temperature is measured via the outdoor ambient temperature sensor, make sure to install the outdoor unit in the shade, or a canopy should be constructed to avoid direct sunlight. So that it is not influenced by the sun's heat, otherwise system protection may occur.

2.7 Base Structure

Outdoor unit base structure design should take account of the following considerations:

- A solid base prevents excess vibration and noise. Outdoor unit bases should be constructed on solid ground or on structures of sufficient strength to support the unit's weight.
- Bases should be at least 100mm high to provide sufficient drainage and to prevent water ingress into the base of the unit.
- Either steel or concrete bases may be suitable.
- Outdoor units should not be installed on supporting structures that could be damaged by water build-in in the event of a blocked drain.
- Fix the unit securely to foundation by means of the $\Phi 10$ expansion bolt. It is best to screw in the foundation bolts until their length is 20 mm from the foundation surface.

Figure 3-2.5: Outdoor unit typical concrete base structure design (unit: mm)

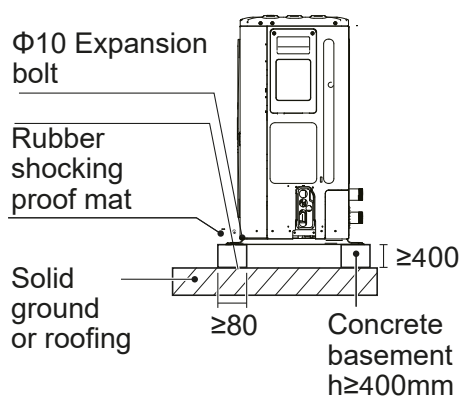

Mono

2.8 Drainage

Drainage ditch should be provided to allow drainage of condensate that may form on the air side heat exchanger when the unit is running in heating mode or domestic hot water mode. The drainage should ensure that condensate is directed away from roadways and footpaths, especially in locations where the climate is such that condensate may freeze.

Figure 3-2.6: 6kW models drainage hole

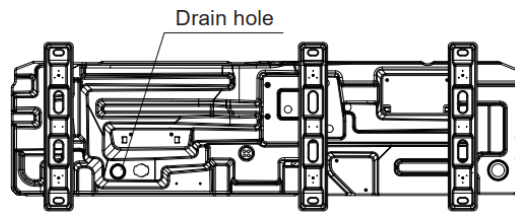
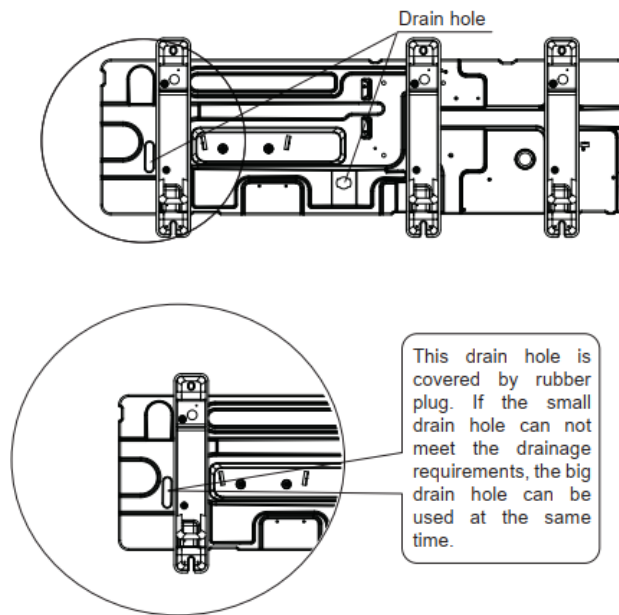

Figure 3-2.7: 8/10/12/14/16kW models drainage hole



2.9 Spacing

2.9.1 Stacked installation

Outdoor units must be spaced such that sufficient air may flow through each unit. Sufficient airflow across heat exchangers is essential for outdoor units to function properly. Figures 3-2.8 and 3-2.9 show the minimum spaces that must be allowed between units and the minimum distances from obstacles in front of and behind units.

Figure 3-2.8: Installation with obstacles in front of the unit

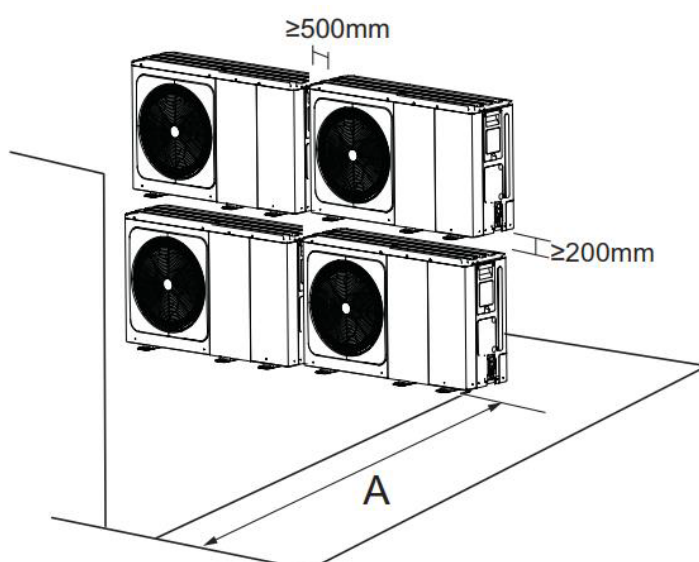
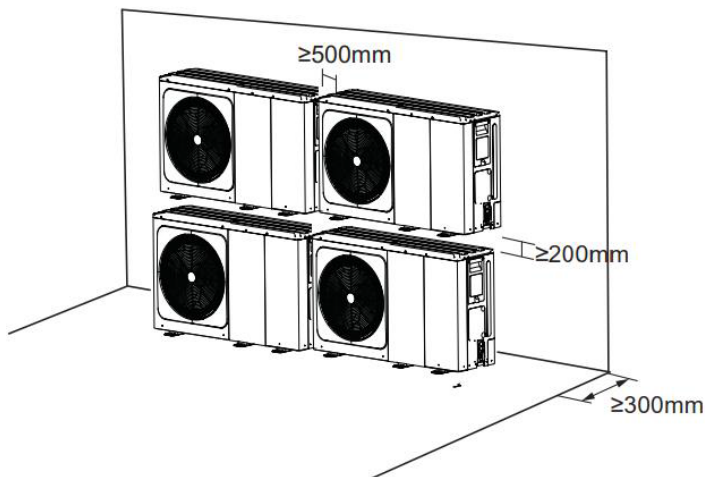

Table 3-2.2: Minimum spacing from obstacles in front of the unit

Model	A(mm)
6kW	≥ 1000
8-16kW	≥ 1500

Figure 3-2.9: Installation with obstacles behind the unit



2.9.2 Installation in Rows

Figure 3-2.10: Multi-row installation

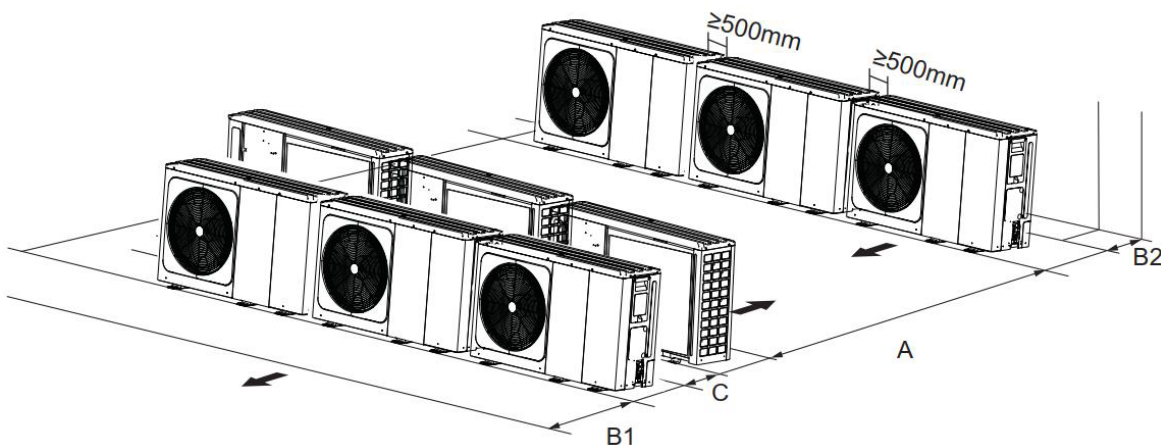

Table 3-2.3: Multiple row installation spacing requirements

Model	A (mm)	B1 (mm)	B2 (mm)	C (mm)
6 kW	≥ 2500	≥ 1000	≥ 300	≥ 600
8-16 kW	≥ 3000	≥ 1500	≥ 300	≥ 600

2.10 Transportation support

For 12/14/16kW model, there is a transportation support which is used to protect tubes from breaking during transportation and this support should be taken off before turning on the heat pump.

Figure 3-2.11: Remove the transportation support

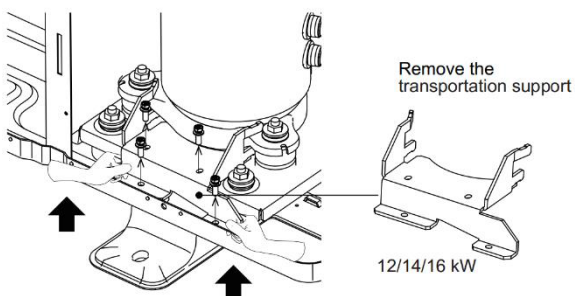

3 Water Pipework

3.1 Water Circuit Checks

Mono units are equipped with a water inlet and outlet for connection to a water circuit. Mono units should only be connected to closed water circuits. Connection to an open water circuit would lead to excessive corrosion of the water piping. Only materials complying with all applicable legislation should be used.

Before continuing installation of the unit, check the following:

- The maximum water pressure ≤ 3 bar.
- The maximum water temperature $\leq 70^{\circ}\text{C}$ according to safety device setting.
- Always use materials that are compatible with the water used in the system and with the materials used in the unit.
- Ensure that components installed in the field piping can withstand the water pressure and temperature.
- Drain taps must be provided at all low points of the system to permit complete drainage of the circuit during maintenance.
- Air vents must be provided at all high points of the system. The vents should be located at points that are easily accessible for service. An automatic air purge is provided inside the unit. Check that this air purge valve is not tightened so that automatic release of air in the water circuit is possible.

3.2 Water Volume and Expansion Vessel Pre-pressure Checks

The units are equipped with an expansion vessel of 8L that has a default pre-pressure of 1.5 bar. To assure proper operation of the unit, the pre-pressure of the expansion vessel might need to be adjusted.

- Check that the total water volume in the installation, excluding the internal water volume of the unit, is at least 40L.
- Expansion vessel volume must fit the total water system volume.
- To size the expansion for the heating and cooling circuit.

The expansion vessel volume can follow the figure below:

Figure 3-3.1: Expansion vessel volume

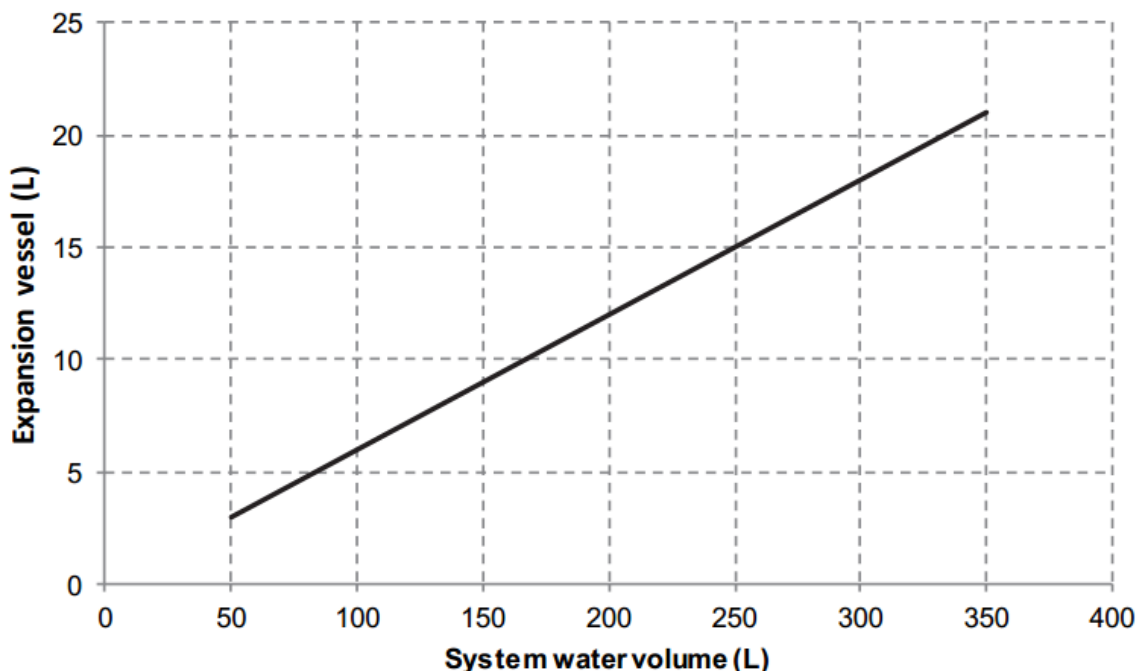

Notes:

- In most applications this minimum water volume will be satisfactory.
- In critical processes or in rooms with a high heat load though, extra water might be required.
- When circulation in each space heating loop is controlled by remotely controlled valves, it is important that this minimum water volume is kept even if all the valves are closed.

3.3 Water Circuit Connection

Water connections must be made correctly in accordance with the labels on the outdoor unit, with respect to the water inlet and water outlet. If air, moisture or dust gets in the water circuit, problems may occur. Therefore, always take into account the following when connecting the water circuit:

- Use clean pipes only.
- Hold the pipe end downwards when removing burrs
- Cover the pipe end when inserting it through a wall to prevent dust and dirt entering.
- Use a good thread sealant for sealing the connections. The sealing must be able to withstand the pressures and temperatures of the system.
- When using non-copper metallic piping, be sure to insulate the two kind of materials from each other to prevent galvanic corrosion.
- For copper is a soft material, use appropriate tools for connecting the water circuit. Inappropriate tools will cause damage to the pipes

3.4 Water Circuit Anti-freeze Protection

Ice formation can cause damage to the hydronic system. All internal hydronic parts are insulated to reduce heat loss. Insulation must also be added to the field piping.

- The software contains special functions using the heat pump to protect the entire system against freezing. When the temperature of the water flow in the system drops to a certain value, the unit will heat the water, either using the heat pump, or the backup heater. The freeze protection function will turn off only when the temperature increases to a certain value.
- In event of a power failure, the above features would not protect the unit from freezing. Since a power failure could happen when the unit is unattended, the supplier recommends use anti-freeze fluid to the water system.
- Depending on the expected lowest outdoor temperature, make sure the water system is filled with a concentration of glycol as mentioned in the table below. When glycol is added to the system, the freezing point of water will be lower and the performance of the unit will be affected. The correction factor of the unit capacity, flow rate and pressure drop of the system is listed in the table 3-3.1 and 3-3.2.

Table 3-3.1: Ethylene Glycol(Toxic)

Concentration of ethylene glycol (%)	Modification coefficient				Minimum outdoor temperature(°C)
	Cooling capacity modification	Power input modification	Water resistance	Water flow modification	
0	1.000	1.000	1.000	1.000	0
10	0.984	0.998	1.118	1.019	-5
20	0.973	0.995	1.268	1.051	-15
30	0.965	0.992	1.482	1.092	-25

Table 3-3.2: Propylene Glycol(Low Toxic; Including the necessary inhibitors, classified as Category III according to EN1717)

Concentration of propylene glycol (%)	Modification coefficient				Minimum outdoor temperature(°C)
	Cooling capacity modification	Power input modification	Water resistance	Water flow modification	
0	1.000	1.000	1.000	1.000	0
10	0.976	0.996	1.071	1.000	-4
20	0.961	0.992	1.189	1.016	-12
30	0.948	0.988	1.380	1.034	-20

Glycol absorbs water from its environment. Therefore do NOT add glycol that has been exposed to air. Leaving the cap off the glycol container causes the concentration of water to increase. The glycol concentration is then lower than assumed.

Mono

As a result, the hydraulic components might freeze up after all. Take preventive actions to ensure a minimal exposure of the glycol to air.

Due to the presence of glycol, corrosion of the system is possible. Uninhibited glycol will turn acidic under the influence of oxygen. This process is accelerated by presence of copper and at higher temperatures. The acidic uninhibited glycol attacks metal surfaces and forms galvanic corrosion cells that cause severe damage to the system. It is of extreme importance:

- That the water treatment is correctly executed by a qualified water specialist.
- That a glycol with corrosion inhibitors is selected to counteract acids formed by the oxidation of glycols.
- That in case of an installation with a domestic hot water tank, only the use of propylene glycol is allowed. If the system does NOT contain a domestic hot water tank, then you can use either propylene glycol or ethylene glycol;
- That no automotive glycol is used because their corrosion inhibitors have a limited lifetime and contain silicates that can foul or plug the system;
- That galvanized piping is not used in glycol systems since it may lead to the precipitation of certain elements in the glycol's corrosion inhibitor;
- To ensure that the glycol is compatible with the materials used in the system.
- Protection against bursting: the glycol will prevent the piping from bursting, but NOT the liquid inside the piping from freezing.
- Protection against freezing: the glycol will prevent the liquid inside the piping from freezing.
- The required concentration might differ depending on the type of glycol. ALWAYS compare the requirements from the table above with the specifications provided by the glycol manufacturer. If necessary, meet the requirements set by the glycol manufacturer.
- If the liquid in the system is frozen, the pump will NOT be able to start. Mind that if you only prevent the system from bursting, the liquid inside might still freeze.
- When water is at standstill inside the system, the system is very likely to freeze and get damaged.

3.5 Water Flow Switch

Water may enter into the flow switch and cannot be drained out and may freeze when the temperature is low enough. The flow switch should be removed and dried, then can be reinstalled in the unit.

- Counterclockwise rotation, remove the water flow switch.
- Drying the water flow switch completely.

3.6 Adding Water

- Connect the water supply to the fill valve and open the valve.
- Make sure the automatic air purge valve is open (at least 2 turns). Refer to Figure 3-3.3.
- Fill with water until the manometer indicates a pressure of approximately 2.0 bars. Remove air in the circuit as much as possible using the air purge valve. Air in the water circuit could lead to malfunction of the backup electric heater.

3.7 Water Piping Insulation

The complete water circuit including all piping, water piping must be insulated to prevent condensation during cooling operation and reduction of the heating and cooling capacity as well as prevention of freezing of the outside water piping during winter. The insulation material should at least of B1 fire resistance rating and complies with all applicable legislation. The thickness of the sealing materials must be at least 13mm with thermal conductivity 0.039W/mK in order to prevent freezing on the outside water piping. If the outdoor ambient temperature is higher than 30°C and the humidity is higher than RH 80%, the thickness of the sealing materials should be at least 20mm in order to avoid condensation on the surface of the seal.

Figure 3-3.2: Water flow switch

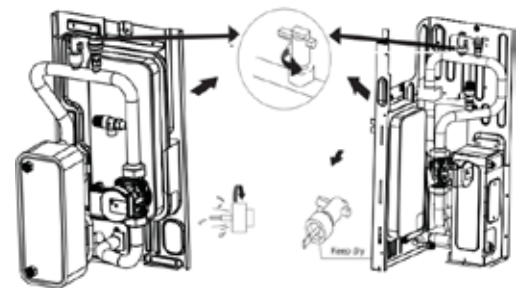
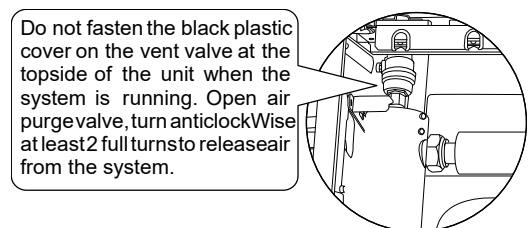

Figure 3-3.3: Air purge valve



4 Electrical Wiring

4.1 General

Notes for installers



Caution

- All installation and wiring must be carried out by competent and suitably qualified, certified and accredited professionals and in accordance with all applicable legislation.
- Electrical systems should be grounded in accordance with all applicable legislation.
- Overcurrent circuit breakers and residual-current circuit breakers (ground fault circuit interrupters) should be used in accordance with all applicable legislation.
- Wiring patterns shown in this data book are general connection guides only and are not intended for, or to include all details for, any specific installation.
- The water piping, power wiring and communication wiring are typically run in parallel. However the communication wiring should not be bound together with power wiring. To prevent signal interference, the power wiring and communication wiring should not be run in the same conduit. If the power supply is less than 10A, a separation of at least 300mm between power wiring and communication wiring conduits should be maintained; if the power supply is in the range 10A to 50A then a separation of at least 500mm should be maintained.

4.2 Precautions

- Fix cables so that cables do not make contact with the pipes (especially on the high pressure side).
- Secure the electrical wiring with cable ties as shown in Figure 3-1.14 and Figure 3-1.15. So that it does not come in contact with the piping, particularly on the high-pressure side.

Figure 3-4.1: Wiring hole for 6kW models

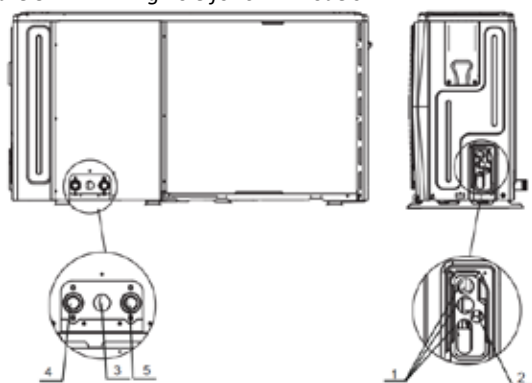

Legend	
1	High voltage wire hole
2	Low voltage wire hole
3	Drainage pipe hole
4	Water outlet
5	Water inlet

Figure 3-4.2: Wiring hole for 8~16kW models

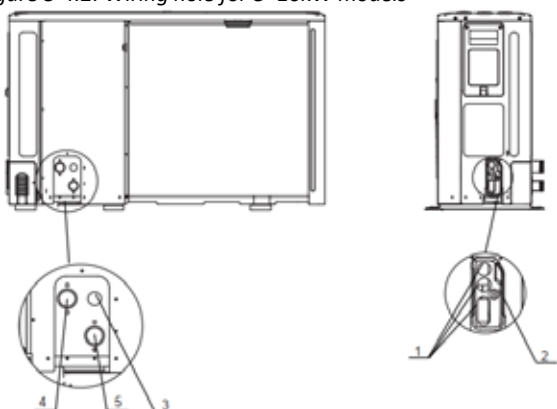

Legend	
1	High voltage wire hole
2	Low voltage wire hole
3	Drainage pipe hole
4	Water outlet
5	Water inlet

Mono

- Make sure no external pressure is applied to the terminal connectors.
- When installing the ground fault circuit interrupter make sure that it is compatible with the inverter (resistant to high frequency electrical noise) to avoid unnecessary opening of the ground fault circuit interrupter
- This unit is equipped with an inverter. Installing a phase advancing capacitor not only reduce the power factor improvement effect, but also may cause abnormal heating of the capacitor due to high frequency waves. Never install a phase advancing capacitor as it could lead to an accident.

4.3 Guidance

- Most field wiring on the unit is to be made on the terminal block inside the switch box. To gain access to the terminal block, remove the switch box service panel.
- Fix all cables using cable ties.
- A dedicated power circuit is required for the backup electric heater.
- Installation equipped with a domestic hot water tank (field supplied) requires a dedicated power circuit for the immersion heater.

Secure the wiring in the order shown below:

- Lay out the electrical wiring so that the front cover does not rise up when doing wiring work and attach the front cover securely.
- Follow the electric wiring diagrams for electrical wiring works. Refer to Figure 2-4.1, Figure 2-4.2 and Figure 2-4.3 in part 2, 4 “Wiring Diagram”.
- Install the wires and fix the cover firmly so that the cover may be fit in properly.

4.4 Wiring Overview

Figure 3-4.3: Wiring overview for 6 kW models

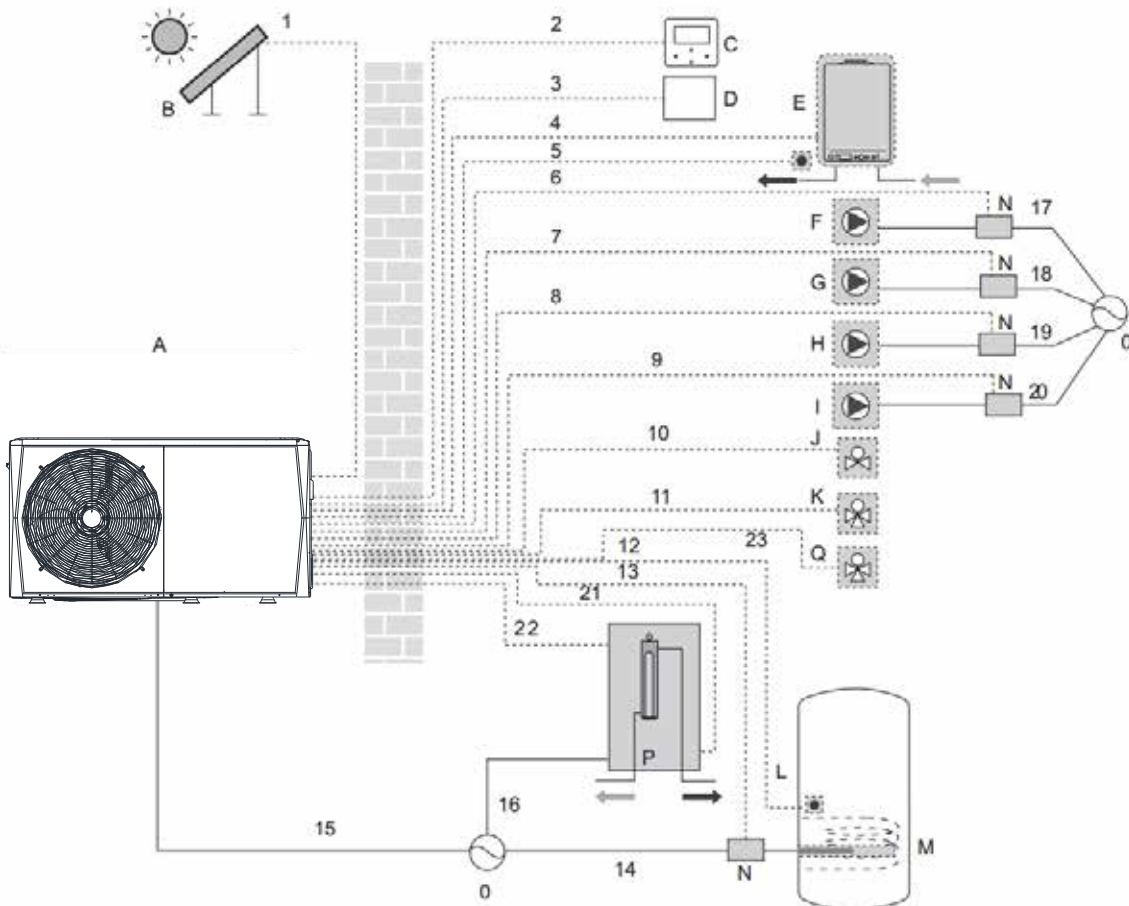
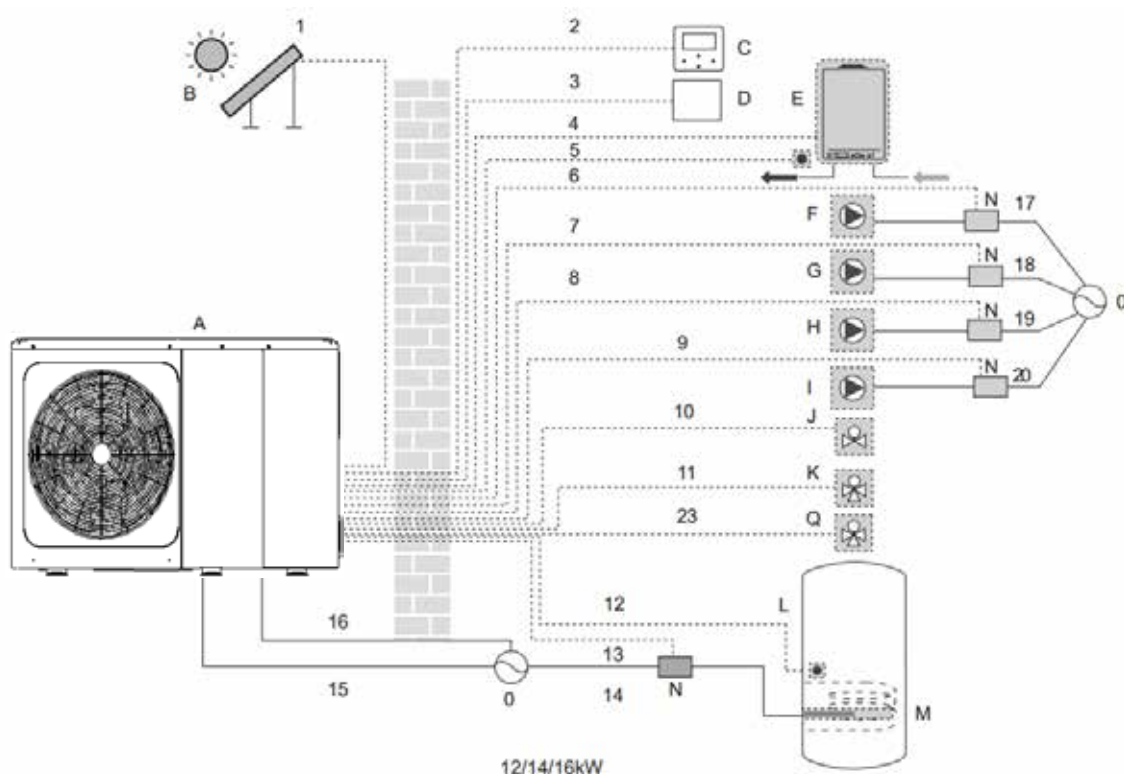

Figure 3-4.4: Wiring overview for 8/10/12/14/16kW models





Item	Description	Item	Description
A	Outdoor unit	J	SV2: 3-way valve (field supply)
B	Solar energy kit (field supply)	K	SV1: 3-way valve for domestic hot water tank (field supply)
C	User interface	L	Domestic hot water tank
D	Room thermostat (field supply)	M	Booster heater
E	Boiler (field supply)	N	Contactor
F	P_s: Solar pump (field supply)	O	Power supply
G	P_c: Mixing pump (field supply)	P	Backup heater
H	P_o: Outside circulation pump (field supply)	Q	Zone2 SV3(3-way valve)
I	P_d: DHW pump (field supply)		

Table 3-4.1: Wiring requirements

Item	Description	AC/DC	Required number of conductors	Maximum running current
1	Solar energy kit signal cable	AC	2	200mA
2	User interface cable	AC	5	200mA
3	Room thermostat cable	AC	2 or 3	200mA(a)
4	Boiler control cable	/	2	200mA
5	Thermistor cable for T1B	DC	2	(b)
9	DHW pump control cable	AC	2	200mA(a)
10	3-way valve control cable	AC	2	200mA(a)
11	3-way valve control cable	AC	2 or 3	200mAC
12	Thermistor cable	DC	2	(b)
13	Booster heater control cable	AC	2	200mA(a)
15	Power supply cable for unit	AC	2+GND(1-Phase) 3+GND(3-Phase)	31A (1-Phase) 15A (3-Phase)
16	Power supply cable for backup heater	AC	2+GND(1-Phase) 3+GND(3-Phase)	14A (1-Phase) 6A (3-Phase)

5 DIP Switch Settings

DIP switch is located on the hydraulic module main control board and allows configuration of additional heating source thermistor installation, the second inner backup heater installation, etc.

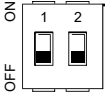
Switch		ON=1	OFF=0	Factory defaults
 <p>S1</p>	1/2	00=IBH(One-step control) 01=IBH(Two-step control) 11=IBH(Three-step control)		Set according to unit configuration by factory
	3/4	00=Without IBH and AHS 10=With IBH 01=With AHS for heating mode 11=With AHS for heating mode and DHW		Set according to unit configuration by factory or adjust onsite according to applicaiton
 <p>S2</p>	1	Start pumpo after 24 hours will be invalid	Start pumpo after 24 hours will be valid	OFF
	2	without TBH	with TBH	OFF
	3/4	Pump configuration		ON/ON
 <p>S4</p>	1	Master unit: clear address of all slave units Slave unit: clear its own address	Keep the current address	OFF
	2	IBH for DHW=valid	IBH for DHW=invalid	OFF
	3/4	Reserved		OFF/OFF
 <p>S9</p>	1/2	00=Slave unit 11=Msater unit		Set according to applicaiton

6 Internal Circulation Pump

The pump is controlled via a digital low-voltage pulse-width modulation signal which means that the speed of rotation depends on the input signal. The speed changes as a function of the input profile. The relationship between external static pressure and water flow rate is described in Part 2, 7 "Hydronic Performance".

Figure 3-6.1: Internal circulation pump

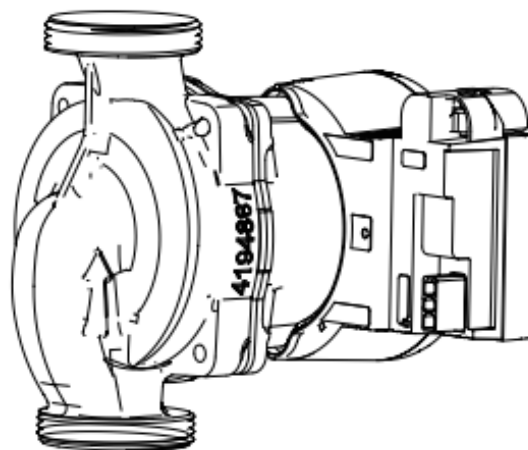

7 User Interface Field Settings

7.1 Introduction

During installation, the Mono's settings and parameters should be configured by the installer to suit the installation configuration, climate conditions and end-user preferences. The relevant settings are accessible and programmable through the FOR SERVICEMAN menu on the Mono's user interface. The user interface menus and settings can be navigated using the user interface's touch-sensitive keys, as detailed in Table 3-7.1.

Figure 3-7.1: User interface

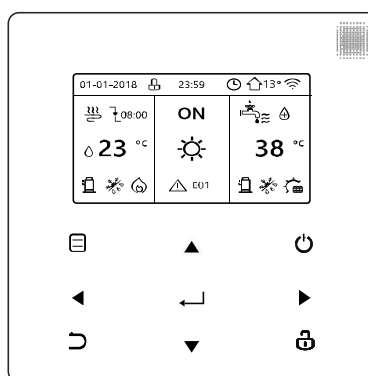
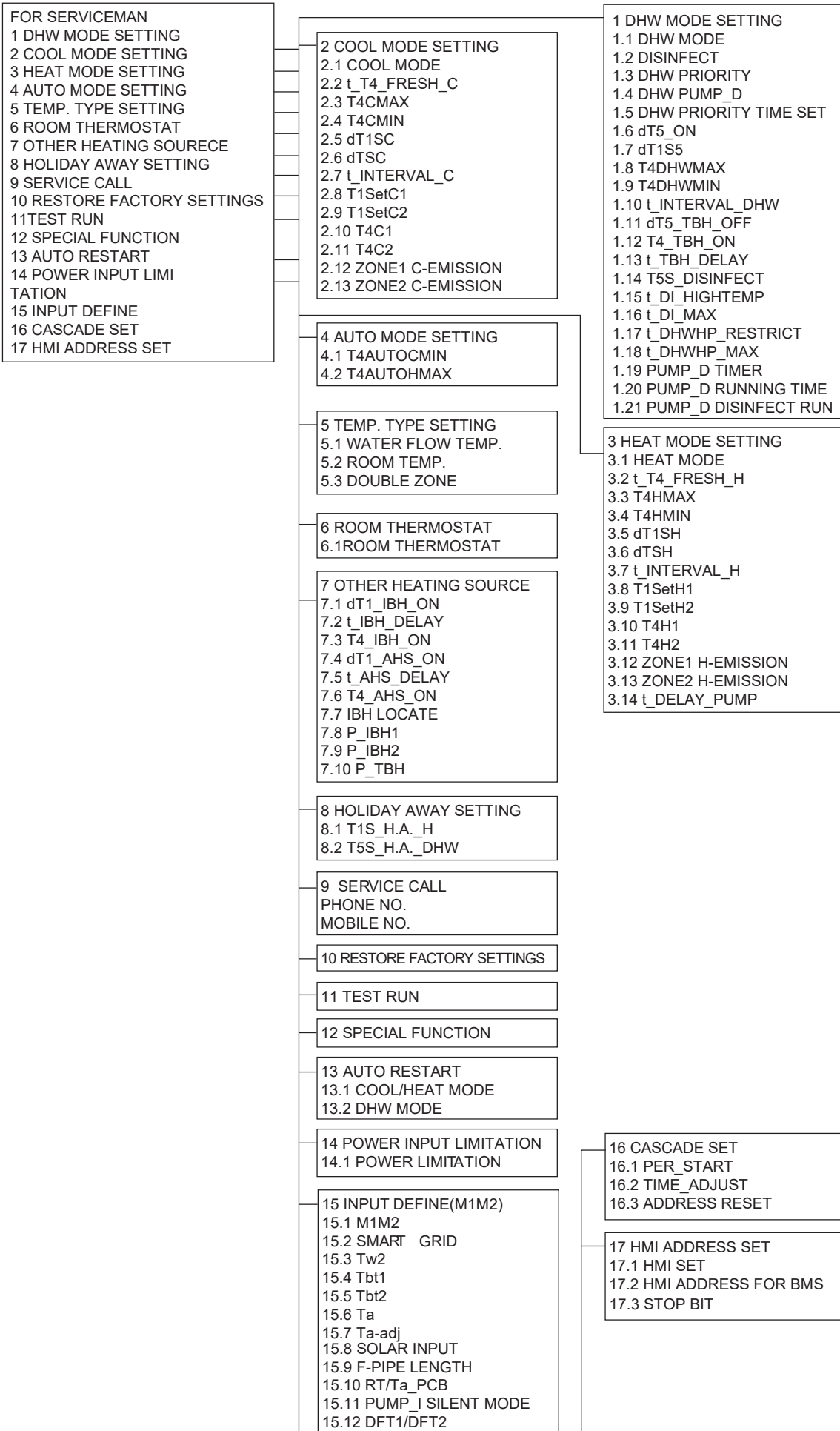

Table 3-7.1: User interface keys

Keys	Function
☰	Go to the menu structure(on the home page)
▲	Navigate the cursor on the display
◀ ▶	Navigate in the menu structure
▼	Adjust settings
⏻	Turn on/off the space heating/cooling operation or DHW mode Turn on/off functions in the menu structure
↶	Come back to the up level
🔒	Long press for unlock/lock the controller Unlock /lock some functions such as "DHW temperature adjusting"
↵	Go to the next step when programming a schedule in the menu structure and confirm a selection to enter in the submenu of the menu structure.

7.2 Menu Structure



7.3 FOR SERVICEMAN Menu

FOR SERVICEMAN allows installers to input the system configuration and set the system parameters. To enter **FOR SERVICEMAN**, go to **MENU > FOR SERVICEMAN**.

Enter the password, using ◀ ▶ to navigate between digits and using ▼ ▲ to adjust the numerical values, and then press **OK**. The password is 234. Refer to Figure 3-7.2

Then the following pages will be displayed after putting the password. Refer to Figure 3-7.3

Figure 3-7.2: FOR SERVICEMAN password screen

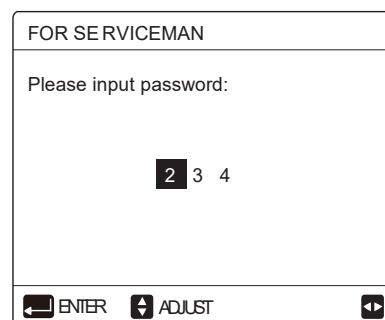

Figure 3-7.3: FOR SERVICEMAN menu

FOR SERVICEMAN 1/3	FOR SERVICEMAN 2/3	FOR SERVICEMAN 3/3
1. DHW MODE SETTING	7. OTHER HEATING SOURCE	13. AUTO RESTART
2. COOL MODE SETTING	8. HOLIDAY AWAY SETTING	14. POWER INPUT LIMITATION
3. HEAT MODE SETTING	9. SERVICE CALL SETTING	15. INPUT DEFINE
4. AUTO MODE SETTING	10. RESTORE FACTORY SETTINGS	16. CASCADE SET
5. TEMP.TYPE SETTING	11. TEST RUN	17. HMI ADDRESS SET
6. ROOM THERMOSTAT	12. SPECIAL FUNCTION	
ENTER	ENTER	ENTER

7.4 DHW MODE SETTING Menu

7.4.1 DHW MODE SETTING menu overview

MENU > FOR SERVICEMAN > DHW MODE SETTING

Figure 3-7.4: DHW MODE SETTING menu

1 DHW MODE SETTING 1/5	1 DHW MODE SETTING 2/5	1 DHW MODE SETTING 3/5
1.1 DHW MODE YES	1.6 dT5_ON 5 °C	1.11 dT5_TBH_OFF 5 °C
1.2 DISINFECT YES	1.7 dT1S5 10 °C	1.12 T4_TBH_ON 5 °C
1.3 DHW PRIORITY YES	1.8 T4DHWMAX 43 °C	1.13 t_TBH_DELAY 30 MIN
1.4 DHW PUMP_D YES	1.9 T4DHWMIN -10 °C	1.14 T5S_DISINFECT 65 °C
1.5 DHW PRIORITY TIME SET NON	1.10 t_INTERVAL_DHW 5 MIN	1.15 t_DI_HIGHTEMP. 15MIN
ADJUST	ADJUST	ADJUST
1 DHW MODE SETTING 4/5	1 DHW MODE SETTING 5/5	
1.16 t_DI_MAX 210 MIN	1.21 PUMP_D DISINFECT RUN NON	
1.17 t_DHWHP_RESTRICT 30 MIN		
1.18 t_DHWHP_MAX 120 MIN		
1.19 PUMP_D TIMER YES		
1.20 PUMP_D RUNNING TIME 5 MIN		
ADJUST	ADJUST	

In **DHW MODE SETTING** the following parameters should be set.

DHW MODE enables or disables DHW mode. For installations with DHW tanks, select **YES** to enable DHW mode. For installations without DHW tanks, select **NON** to disable DHW mode.

DISINFECT sets whether or not the disinfection operation is performed.

DHW PRIORITY sets whether domestic hot water heating or space heating/cooling takes priority. If **NON** is selected in the **DHW PRIORITY** mode, when it is available and the space heating/cooling is **OFF**, the heat pump will heat the water as required. If space heating/cooling is **ON**, the water will be heated as required when the immersion heater is unavailable.

Mono

Only when the space heating/cooling is **OFF** will the heat pump operate to heat domestic water.

DHW PUMP_D sets whether or not the DHW pump is controlled by the Mono heat pump. If the DHW pump is to be controlled by the Mono unit, select **YES**. If the DHW pump is not to be controlled by the Mono unit, select **NON**.

DHW PUMP PRIORITY TIME SET set the operation time of DHW during **DHW PRIORITY** mode.

dT5_ON sets the temperature difference between the DHW set temperature (T5S) and the DHW tank water temperature (T5) above which the heat pump providing heated water to the DHW tank. When $T5S - T5 \geq dT5_ON$ the heat pump providing heated water to the DHW tank.

Note: When the heat pump's leaving water temperature is above the DHW mode leaving water temperature operating limit (T5stop), the heat pump does not provide heated water to the DHW tank. The DHW mode leaving water temperature operating limit is related to ambient temperature as shown in Figure 2-6.3 in Part 2, 6 "Operating Limits".

dT1S5 sets the heat pump's leaving water set temperature

(T1S) relative to DHW tank water temperature (T5). For DHW mode, the user sets the DHW set temperature (T5S) on the main screen and cannot manually set T1S. T1S is set as $T1S = T5 + dT1S5$.

Figure 3-7.6 illustrates the operation of the heat pump and immersion heater(optional) in DHW mode. If the DHW tank water temperature (T5) is less than the minimum of the DHW set temperature (T5S) and the heat pump leaving water temperature operating limit (T5stop) (refer to Figure 2-6.3 in Part 2, 6 "Operating Limits") less **dT5_ON**, the heat pump starts providing heated water to the DHW tank. After **t_TBH_delay** minutes have elapsed, the immersion heater is turned on. If T5 reaches T5stop, the heat pump stops but the immersion heater continues running until T5 has reached $T5S + dT5_TBH_OFF$

T4DHWMAX sets the ambient temperature above which the heat pump will not operate in DHW mode. The highest value that **T4DHWMAX** can take is 43°C, which is the DHW mode upper ambient temperature operating limit of the heat pump.

T4DHWMIN sets the ambient temperature below which the heat pump will not operate in DHW mode. The lowest value that **T4DHWMIN** can take is -25°C, which is the DHW mode lower ambient temperature operating limit of the heat pump.

Figure 3-7.5: dT5_ON

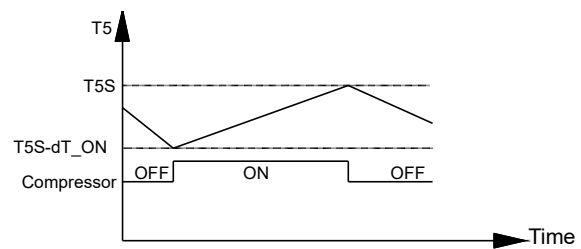

Abbreviations:
T5: DHW tank water temperature
T5S: DHW set temperature

Figure 3-7.6: DHW mode operation

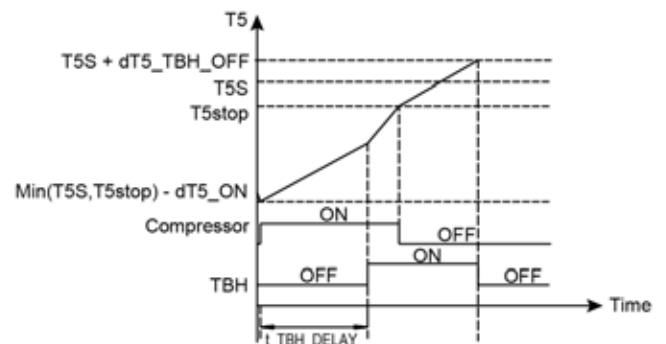

Abbreviations:
T5: DHW tank water temperature
T5S: DHW set temperature
T5stop: DHW mode leaving water temperature operating limit
TBH: Immersion heater in DHW tank

Figure 3-7.7: T4DHWMAX and T4DHWMIN



Abbreviations:
HP: Heat pump
TBH: DWH tank immersion heater
AHS: Additional heating source

t_INTERVAL_DHW sets the DHW mode compressor re-start delay. When the compressor stops running, it will not re-start until at least **t_INTERVAL_DHW** minutes have elapsed.

dT5_TBH_OFF sets the temperature difference between the DHW set temperature (T5S) and the DHW tank water temperature (T5) below which the immersion is not used. When $T5 \geq \text{Min}(T5S + dT5_TBH_OFF, 65^\circ\text{C})$, the immersion heater is off.

T4_TBH_ON sets the ambient temperature above which the immersion heater will not be used.

t_TBH_DELAY sets the delay between the compressor starting and the immersion heater being turned on.

T5S_DISINFECT sets the DHW tank disinfection operation target temperature. Caution: during the disinfection operation (duration: **t_DI_MAX**) the domestic hot water temperature at the hot water taps will at times be equal to the value set for **T5S_DI**.

t_DI_HIGHTEMP sets that length of time that the DHW tank disinfection operation target temperature is maintained.

t_DI_MAX sets the total duration of the DHW tank disinfect operation.

t_DHWHP_RESTRICT sets the maximum length of time that the heat pump will run in space heating or space cooling modes before switching to DHW mode, if a requirement for DHW mode exists. When running in space heating mode or space cooling mode, the heat pump becomes available for DHW mode either as soon as the space heating/cooling set temperatures have been reached (refer to Part 3, 7.5 "COOL MODE SETTING Menu" and Part 3, 7.6 "HEAT MODE SETTING Menu") or after **t_DHWHP_MAX** minutes have elapsed.

t_DHWHP_MAX sets the maximum length of time that the heat pump will run in DWH mode before switching to space heating mode or space cooling mode if a requirement for space heating/cooling modes exists. When running in DHW mode, the heat pump becomes available for space heating/cooling either as soon as the DHW tank water temperature (T5) reaches the DHW set temperature (T5S) or after **t_DHWHP_MAX** minutes have elapsed.

Figure 3-7.8: DHW tank disinfection

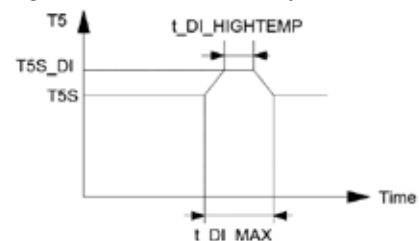

Abbreviations:
 T5: DHW tank water temperature
 T5S: DHW set temperature

Figure 3-7.9 illustrates the effects of **t_DHWHP_MAX** and **t_DHWHP_RESTRICT** when **DHW PRIORITY** is enabled. The heat pump initially runs in DWH mode. After **t_DHWHP_MAX** minutes, T5 has not reached

Figure 3-7.9: Operation in DHW PRIORITY

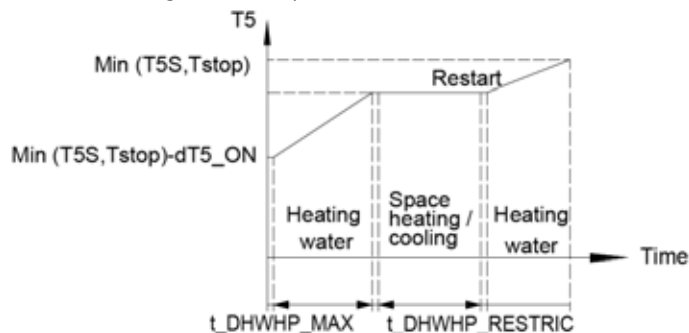

Abbreviations:
 T5: DHW tank water temperature
 T5S: DHW set temperature
 T5stop: DHW mode leaving water temperature operating limit

Mono

PUMP_D TIMER sets whether or not the user is able to set the DHW pump (field supply) in DHW mode. For installations with a DHW pump, select ON so that the user is able to set pump start times.

PUMP_D RUNNING TIME sets the length of time the pump runs for at each of the user-specified start times on the **DHW PUMP** tab on the **DOMESTIC HOT WATER (DHW)** menu, if **TIMER RUNNING** is enabled.

PUMP_D DISINFECT RUN sets whether or not the DHW pump (field supply) operates during the disinfection mode.

7.5 COOL MODE SETTING Menu

MENU > FOR SERVICEMAN > COOL MODE SETTING

Figure 3-7.10: COOL MODE SETTING menu

2 COOL MODE SETTING	1/3	2 COOL MODE SETTING	2/3	2 COOL MODE SETTING	3/3
2.1 COOL MODE	YES	2.6 dTSC	2 °C	2.11 T4C2	25 °C
2.2 t_T4_FRESH_C	2.0HRS	2.7 t_INTERVAL_C	5MIN	2.12 ZONE1 C-EMISSION	FCU
2.3 T4CMAX	43°C	2.8 T1SetC1	10°C	2.13 ZONE2 C-EMISSION	FLH
2.4 T4CMIN	20°C	2.9 T1SetC2	16°C		
2.5 dT1SC	5°C	2.10 T4C1	35°C		
↕ ADJUST	↔	↕ ADJUST	↔	↕ ADJUST	↔

In **COOL MODE SETTING** the following parameters should be set.

COOL MODE enables or disables cooling mode. For installations with space cooling terminals, select **YES** to enable cooling mode. For installations without space cooling terminals, select **NON** to disable cooling mode.

t_T4_FRESH_C sets the refresh time of cooling model climate temperature curve.

T4CMAX sets the ambient temperature above which the heat pump will operate in cooling mode with lowest compressor frequency. The highest value that **T4CMAX** can take is 46°C, which is the cooling mode upper ambient temperature operating limit of the heat pump. Refer to Figure 3-7.11.

Figure 3-7.11: T4CMAX, T4CMIN

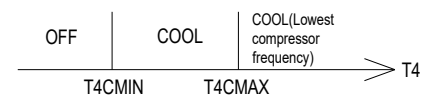

Abbreviations:
T4: Outdoor ambient temperature

T4CMIN sets the ambient temperature below which the heat pump will not operate in cooling mode. The lowest value that **T4CMIN** can take is -5°C, which is the cooling mode lower ambient temperature operating limit of the heat pump. Refer to Figure 3-7.11.

dT1SC sets the minimum temperature difference between the heat pump leaving water temperature (T1) and the heat pump leaving water set temperature (T1S) at which the heat pump provides chilled water to the space cooling terminals. When $T1 - T1S \geq dT1SC$ the heat pump provides chilled water to the space cooling terminals and when $T1 \leq T1S$ the heat pump does not provide chilled water to the space cooling terminals.

Figure 3-7.12: dT1SC

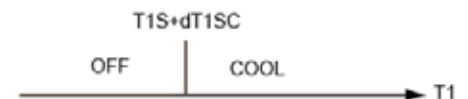

Abbreviations:
T1: Heat pump leaving water temperature
T1S: Heat pump leaving water set temperature

dTSC sets the temperature difference between the actual room temperature (Ta) and set room temperature (TS) above which the heat pump provides chilled water to the space cooling terminals. When $Ta - TS \geq dTSC$ the heat pump provides chilled water to the space cooling terminals and when $Ta \leq TS$ the heat pump does not provide chilled water to the space cooling terminals. Refer to Figure 3-7.13. **dTSC** is only applicable if **YES** is selected for **ROOM TEMP** in the **TEMP. TYPE SETTING** menu. Refer to Part 3,

Figure 3-7.13: dTSC

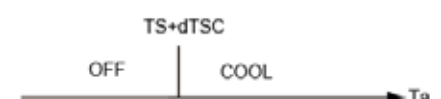

7.8 “TEMP. TYPE SETTING Menu”.

t_INTERVAL_C sets the cooling mode compressor re-start delay. When the compressor stops running, it will not re-start until at least **t_INTERVAL_C** minutes have elapsed.

T1SetC1 sets the temperature 1 of automatic setting curve for cooling mode.

T1SetC2 sets the temperature 2 of automatic setting curve for cooling mode.

T4C1 sets the ambient temperature 1 of automatic setting curve for cooling mode.

T4C2 sets the ambient temperature 2 of automatic setting curve for cooling mode.

ZONE1 C-EMISSION sets the emission type of zone1 for cooling mode.

ZONE2 C-EMISSION sets the emission type of zone2 for cooling mode.

7.6 HEAT MODE SETTING Menu

MENU > FOR SERVICEMAN > HEAT MODE SETTING

Figure 3-7.14: HEAT MODE SETTING menu

3 HEAT MODE SETTING 1/3	3 HEAT MODE SETTING 2/3	3 HEAT MODE SETTING 3/3
3.1 HEAT MODE YES	3.6 dTSH 2 °C	3.11 T4H2 7 °C
3.2 t_T4_FRESH_H 2.0HRS	3.7 t_INTERVAL_H 5MIN	3.12 ZONE1 H-EMISSION RAD.
3.3 T4HMAX 16°C	3.8 T1SetH1 35°C	3.13 ZONE2 H-EMISSION FLH
3.4 T4HMIN -15°C	3.9 T1SetH2 28°C	3.14 t_DELAY_PUMP 2MIN
3.5 dT1SH 5°C	3.10 T4H1 -5°C	
↕ ADJUST ▶	↕ ADJUST ▶	↕ ADJUST ▶

In **HEAT MODE SETTING** the following parameters should be set.

HEAT MODE enables or disables heating mode.

t_T4_FRESH_H sets the refresh time of heating model climate temperature curve.

T4HMAX sets the ambient temperature above which the heat pump will operate heating mode with lowest compressor frequency. The highest value that **T4HMAX** can take is 35°C, which is the heating mode upper ambient temperature operating limit of the heat pump. Refer to Figure 3-7.15.

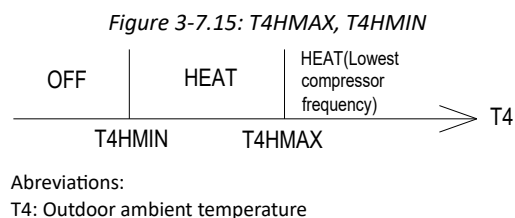

T4HMIN sets the ambient temperature below which the heat pump will not operate in heating mode. The lowest value that **T4HMIN** can take is -25°C, which is the heating mode lower ambient temperature operating limit of the heat pump. Refer to Figure 3-7.15.

Mono

dT1SH sets the temperature difference between the heat pump leaving water temperature (T1) and the heat pump leaving water set temperature (T1S) above which the heat pump provides heated water to the space heating terminals.

Figure 3-7.16: dTSH



Note:
Only when ROOM TEMP is enabled will this function be available

dTSH sets the temperature difference between the actual room temperature (Ta) and set room temperature (TS) above which the heat pump provides heated water to the space heating terminals. When $TS - Ta \geq dTSH$ the heat pump provides heated water to the space heating terminals and when $Ta \geq TS$ the heat pump does not provide heated water to the space heating terminals. Refer to Figure 3-7.16. **dTSH** is only relevant if **YES** is selected for **ROOM TEMP** in the **TEMP. TYPE SETTING** menu. Refer to Part 3, 7.8 “TEMP. TYPE SETTING Menu”.

t_INTERVAL_H sets the heating mode compressor re-start delay. When the compressor stops running, it will not re-start until at least **t_INTERVAL_H** minutes have elapsed.

T1SetH1 sets the temperature 1 of automatic setting curve for heating mode.

T1SetH2 sets the temperature 2 of automatic setting curve for heating mode.

T4H1 sets the ambient temperature 1 of automatic setting curve for heating mode.

T4H2 sets the ambient temperature 2 of automatic setting curve for heating mode.

ZONE1 H-EMISSION sets the emission type for heating mode.

ZONE2 H-EMISSION sets the emission type for heating mode.

7.7 AUTO MODE SETTING Menu

MENU > FOR SERVICEMAN > AUTO MODE SETTING

In **AUTO MODE SETTING** the following parameters should be set.

T4AUTOCMIN sets the ambient temperature below which the heat pump will not provide chilled water for space cooling in auto mode. Refer to Figure 3-7.18.

T4AUTOHMAX sets the ambient temperature above which the heat pump will not provide heated water for space heating in auto mode. Refer to Figure 3-7.18.

Figure 3-7.17: AUTO MODE SETTING menu

4 AUTO. MODE SETTING	
4.1 T4AUTOCMIN	25°C
4.2 T4AUTOHMAX	17°C
ADJUST	

Figure 3-7.18: T4AUTOCMAX, T4AUTOCMIN

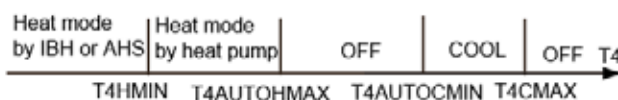

Abbreviations:
 HP: Heat pump
 AHS: Additional heating source
 IBH: Backup electric heater
 T4CMAX: The ambient temperature above which the heat pump will not operate in cooling mode.
 T4HMIN: The ambient temperature below which the heat pump will not operate in heating mode.

7.8 TEMP. TYPE SETTING Menu

MENU > FOR SERVICEMAN > TEMP. TYPE SETTING

The TEMP. TYPE SETTING is used for selecting whether the water flow temperature or room temperature is used to control the ON/OFF of the heat pump.

When ROOM TEMP. is enabled, the target water flow temperature will be calculated from climate-related curves (refer to “9 Climate related curves”).

For installations without room thermostats, space heating and cooling modes can be controlled in one of two different ways:

- according to the Mono’s leaving water temperature alone
- according to the room temperature detected by the Mono user interface’s built-in temperature sensor alone

WATER FLOW TEMP. sets whether space heating/cooling modes are controlled according to the Mono’s leaving water temperature. If **YES** is selected, the user is able to set the Mono unit’s leaving water temperature set temperature on the user interface’s main screen.

ROOM TEMP. sets whether space heating/cooling modes are controlled according to the room temperature detected by the temperature sensor in the Mono user interface. If **YES** is selected, the user is able to set the room temperature set temperature on the user interface’s main screen, no matter what is the setting of **WATER FLOW TEMP.**

DOUBLE ZONE sets whether there are two zones.

If set WATER FLOW TEMP. and ROOM TEMP. to YES, meanwhile set DOUBLE ZONE to NON or YES, the following pages will be displayed. In this case, the setting value of zone 1 is T1S, the setting value of zone 2 is TS(The corresponding TIS2 is calculated according to the climate related curves.)

Figure 3-7.22: DOUBLE ZONE to NON or YES

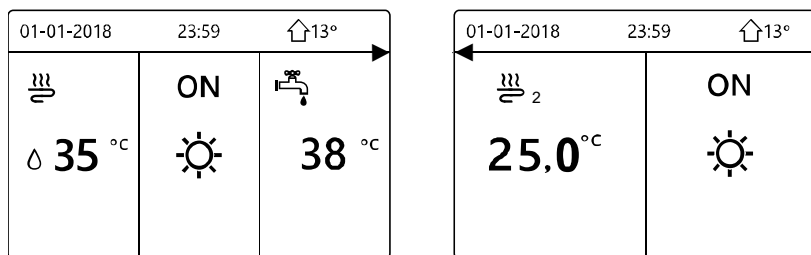

Homepage (zone 1)

Addition page (zone 2)
(Double zone is effective)

If set DOUBLE ZONE to YES and set ROOM TEMP. to NON, meanwhile set WATER FLOW TEMP. to YES or NON, the following pages will be displayed. In this case, the setting value of zone 1 is T1S, the setting value of zone 2 is T1S2.

Figure 3-7.19: TEMP. TYPE SETTING menu

5 TEMP. TYPE SETTING	
5.1 WATER FLOW TEMP.	YES
5.2 ROOM TEMP.	NON
5.3 DOUBLE ZONE	NON
⬅️ ADJUST	➡️

Figure 3-7.20: Only set WATER FLOW TEMP to YES

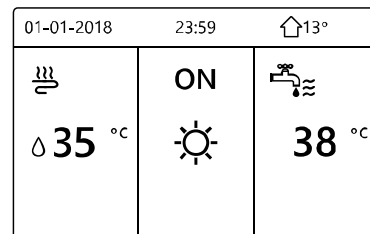

Figure 3-7.21: Only set ROOM TEMP to YES

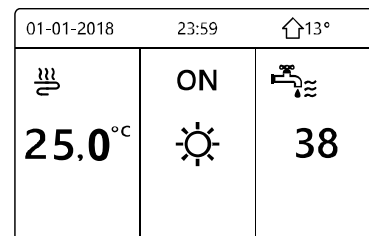
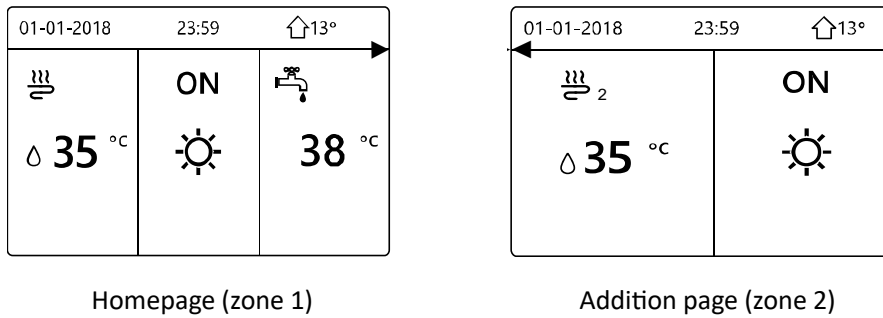
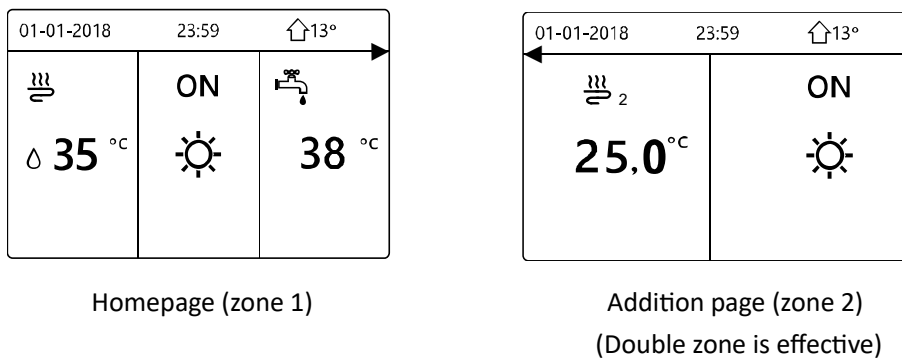

Figure 3-7.23: DOUBLE ZONE to YES and set ROOM TEMP. to NON meanwhile set WATER FLOW TEMP. to YES or NON



If set DOUBLE ZONE and ROOM TEMP. to YES, meanwhile set WATER FLOW TEMP. to YES or NON, the following page will be displayed. In this case, the setting value of zone 1 is T1S, the setting value of zone 2 is TS (The corresponding TIS2 is calculated according to the climate related curves.)

Figure 3-7.24: DOUBLE ZONE and set ROOM TEMP. to YES meanwhile set WATER FLOW TEMP. to YES or NON



7.9 ROOM THERMOSTAT Menu

MENU > FOR SERVICEMAN > ROOM THERMOSTAT

As an alternative to controlling space heating/cooling modes according Mono unit's leaving water temperature and/or the room temperature detected by the temperature sensor in the Mono user interface, separate room thermostat can be installed and used to control space heating/cooling modes.

Figure 3-7.25: ROOM THERMOSTAT menu

6 ROOM THERMOSTAT	
6.1 ROOM THERMOSTAT	NON
ADJUST	

In **ROOM THERMOSTAT** the following parameters should be set.

ROOM THERMOSTAT sets whether or not room thermostats are installed. For installations with room thermostats, select **YES**. For installations without room thermostats, select **NON**.

ROOM THERMOSTAT = NON: No room thermostat.

ROOM THERMOSTAT = MODE SET: Room thermostat can control heating and cooling individually.

ROOM THERMOSTAT=ONE ZONE: Room thermostat provides the switch signal to unit.

ROOM THERMOSTAT=DOUBLE ZONE: Indoor unit is connected with two room thermostat.

7.10 OTHER HEATING SOURCE Menu

7.10.1 OTHER HEATING SOURCE menu overview

MENU > FOR SERVICEMAN > OTHER HEATING SOURCE

Figure 3-7.26: OTHER HEATING SOURCE menu

7 OTHER HEATING SOURCE 1/2	7 OTHER HEATING SOURCE 2/2
7.1 dT1_IBH_ON 5°C	7.6 T4_AHS_ON 5°C
7.2 t_IBH_DELAY 30MIN	7.7 IBH LOCATE PIPE LOOP
7.3 T4_IBH_ON -5°C	7.8 P_IBH1 0.0kW
7.4 dT1_AHS_ON 5°C	7.9 P_IBH2 0.0kW
7.5 t_AHS_DELAY 30MIN	7.10 P_TBH 2.0kW
ADJUST	ADJUST

In **OTHER HEATING SOURCE** the following parameters should be set. Backup electric heater is optional.

dT1_IBH_ON sets the temperature difference between the heat pump’s leaving water set temperature (T1S) and the heat pump’s leaving water temperature (T1) above which the backup electric heater heating element(s) are on. When $T1S - T1 \geq dT1_IBH_ON$ the backup electric heater is on (on models where the backup electric heater has a simple on/off control function).

t_IBH_DELAY sets the delay between the compressor starting and the backup electric heater being turned on.

T4_IBH_ON sets the ambient temperature below which the backup electric heater is used. If the ambient temperature is above **T4_IBH_ON**, the backup electric heater is not used. The relationship between operation of the backup heater and the ambient is shown in Figure 3-7.22.

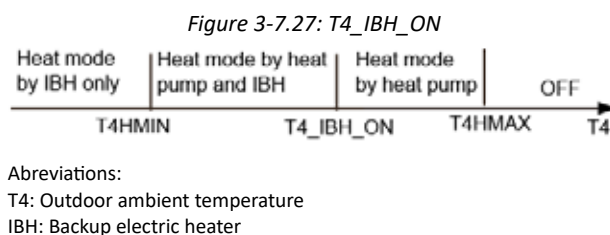

dT1_ASH_ON sets the temperature difference between the heat pump’s leaving water set temperature (T1S) and the heat pump’s leaving water temperature (T1) above which the additional heating source is on. When $T1S - T1 \geq dT1_ASH_ON$ the additional heating source is on.

t_ASH_DELAY sets the delay between the compressor starting and the additional heating source being turned on.

T4_AHS_ON sets the ambient temperature below which the additional heating source is used. If the ambient temperature is above **T4_AHS_ON**, the additional heating source is not used. The relationship between operation of the additional heating source and the ambient is shown in the picture below.

Figure 3-7.28: T4_AHS_ON

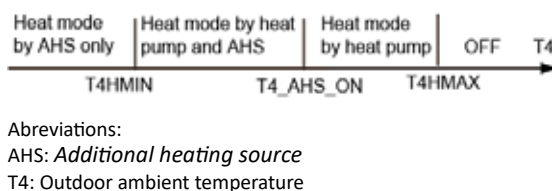

IBH LOCATE means IBH is installed for pipe heating.

P_IBH1, P_IBH2 set heating capacity of IBH and P_TBH sets heating capacity of TBH, which are used for energy consumption statistics.

Mono

7.11 HOLIDAY AWAY SETTING Menu

MENU > FOR SERVICEMAN > HOLIDAY AWAY SETTING

The **HOLIDAY AWAY SETTING** menu settings are used to set the outlet water temperature to prevent water pipes freezing when away from home in cold weather seasons. In **HOLIDAY AWAY SETTING** the following parameters should be set.

T1S_H.A._H sets the heat pump’s leaving water set temperature for space heating mode when in holiday away mode.

T5S_H.M._DHW sets the heat pump’s leaving water set temperature for DHW mode when in holiday away mode.

Figure 3-7.29: HOLIDAY AWAY SETTING menu

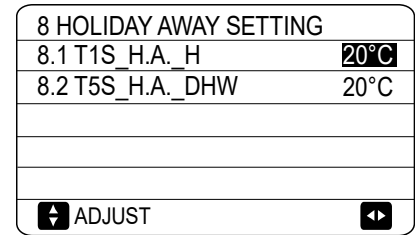

7.12 SERVICE CALL Menu

MENU > FOR SERVICEMAN > SERVICE CALL

In **SERVICE CALL** the following parameters can be set.

PHONE NO. and **MOBILE NO.** can be used to set after-sales service contact numbers. If set, these numbers are displayed to users in **MENU > FOR SERVICEMAN > SERVICE CALL**

Use ▼ ▲ to adjust the numerical values. The maximum length of the phone numbers is 14 digits.

Figure 3-7.30: SERVICE CALL menu

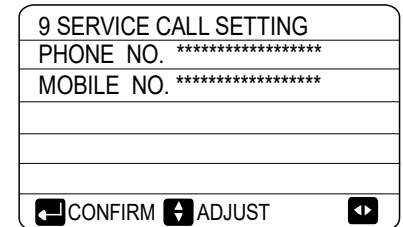

The black rectangle found between 0 and 9 when scrolling up and down using ▼ ▲ is converted to a blank space when the phone numbers are displayed to users in **MENU > FOR SERVICEMAN > SERVICE CALL** and can be used for phone numbers less than 14 digits in length.

7.13 RESTORE FACTORY SETTINGS

MENU > FOR SERVICEMAN > RESTORE FACTORY SETTINGS

RESTORE FACTORY SETTINGS is used to restore all the parameters set in the user interface to their factory defaults.

On selecting **YES**, the process of restoring all settings to their factory defaults begins and progress is displayed as a percentage.

Figure 3-7.31: RESTORE FACTORY SETTINGS screens

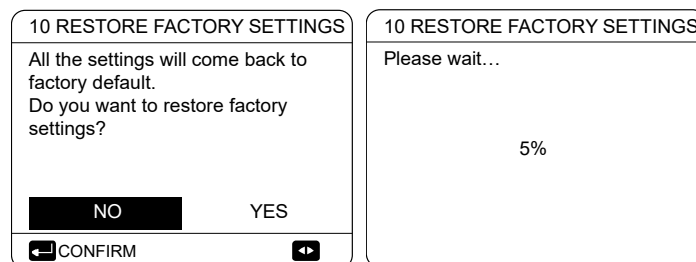

7.14 TEST RUN

7.14.1 TEST RUN Menu overview

MENU > FOR SERVICEMAN > TEST RUN

TEST RUN is used to check that the valves, air purge function, circulation pump, space cooling mode, space heating mode and DHW mode are all operating correctly.

Figure 3-7.32: TEST RUN start screen and TEST RUN menu

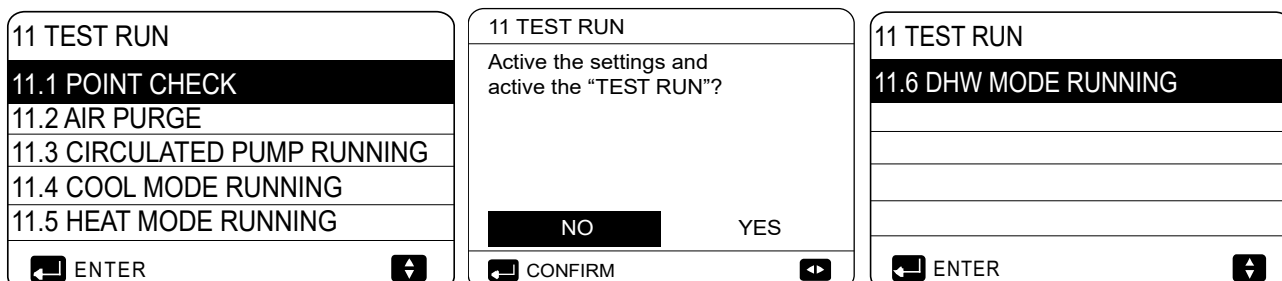

During test run, all buttons except OK are invalid. If you want to turn off the test run, please press OK. For example, when the unit is in air purge mode, after you press OK, the following page will be displayed:

Figure 3-7.33: Exit air purge screen

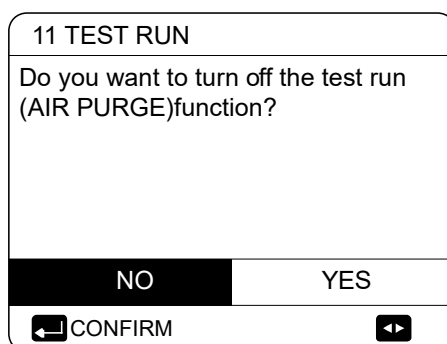

7.14.2 POINT CHECK menu

MENU > FOR SERVICEMAN > TEST RUN > POINT CHECK

The **POINT CHECK** menu is used to check the operation of individual components. Use ▼▲ to scroll to the components you want to check and press ON/OFF to toggle the on/off state of the component. If a valve does not turn on/off when its on/off state is toggled or if a pump/heater does not operate when turned on, check the component’s connection to the hydronic system main PCB.

Figure 3-7.34: POINT CHECK menu

11 TEST RUN	1/2	11 TEST RUN	2/2
3WAY-VALVE 1	OFF	PUMPSOLAR	OFF
3WAY-VALVE 2	OFF	PUMPDHW	OFF
PUMP_I	OFF	INNER BACKUP HEATER	OFF
PUMP_O	OFF	TANK HEATER	OFF
PUMP_C	OFF	3-WAY VALVE 3	OFF
ON/OFF	↕	ON/OFF	↕

Mono

7.14.3 AIR PURGE operation

MENU > FOR SERVICEMAN > TEST RUN > AIR PURGE

Once installation is complete it is important to run the air purge function to remove any air which may be present in the water piping and which could cause malfunctions during operation.

The **AIR PURGE** operation is used to remove air from the water piping. Before running AIR PURGE mode, make sure that the air purge valve is open. When the air purge operation starts, SV1 valve opens and SV2 valve closes. 60 secs later the pump in the unit (PUMPI) operates for 10min during which the flow switch does not work. After the pump stops, SV1 valve closes and SV2 valve opens. 60 secs later both PUMPI and PUMPO operate until the next command is received. If any error code is displayed during the air purge operation, the cause should be investigated. Refer to Part 3, 10 "Error Code table".

Figure 3-7.35: AIR PURGE operation

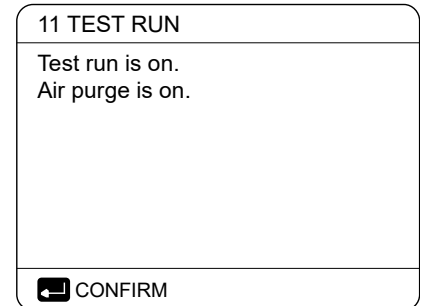

7.14.4 CIRCULATION PUMP RUNNING operation

MENU > FOR SERVICEMAN > TEST RUN > CIRCULATION PUMP RUNNING

The **CIRCULATION PUMP RUNNING** operation is used to check the operation of the circulation pump. When the circulation pump running operation starts, all running components stop. 60 secs later, the 3-way valve opens and the 3-way valve closes. After a further 60 secs PUMPI starts. 30 seconds later, if the flow switch detects that the water flow is normal, PUMPI operates for 3 mins. After the pump stops 60s, the 3-way valve closes and the 3-way valve opens. 60s later both PUMI and PUMPO will operate. After a further 2 mins the flow switch start to check the water flow. If the water flow rate is sufficient, both PUMPI and PUMPO operate until the next command is received. If the water flow rate is insufficient over any 15-second period, PUMPI and PUMPO stop and error code E8 is displayed. Refer to Part 3, 10 "Error Code table".

Figure 3-7.36: CIRCULATION PUMP RUNNING display

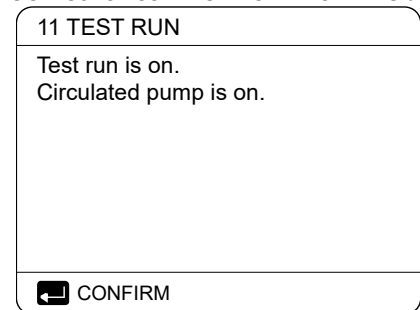

7.14.5 COOL MODE RUNNING operation

MENU > FOR SERVICEMAN > TEST RUN > COOL MODE RUNNING

The **COOL MODE RUNNING** operation is used to check the operation of the system in space cooling mode.

During the **COOL MODE RUNNING** operation, the Mono unit leaving water set temperature is 7°C. The current actual leaving water temperature is displayed on the user interface. The unit operates until the leaving water temperature drops to the set temperature or the next command is received.

Figure 3-7.37: COOL MODE RUNNING display

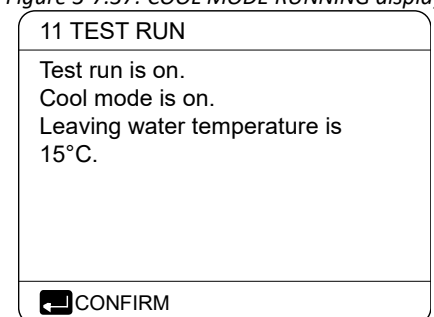

If any error code is displayed during the cool mode running operation, the cause should be investigated. Refer to Part 3, 10 "Error Code table".

7.14.6 HEAT MODE RUNNING operation

The **HEAT MODE RUNNING** operation is used to check the operation of the system in space heating mode.

During the **HEAT MODE RUNNING** operation the Mono unit leaving water set temperature is 35°C. The current actual leaving water temperature is displayed on the user interface. When the **HEAT MODE RUNNING** operation starts, the heat pump first runs for 10 mins.

After 10 mins:

- On systems where an auxiliary heat source (AHS) is installed, the AHS starts and runs for 10 mins (whilst the heat pump continues running), after which the AHS stops and the heat pump continues to operate until the water temperature rises to the set temperature or the heat mode running operation is exited by pressing **OK**.
- On systems where a backup electric heater is being used, the backup heater turn on (on models where the backup heater has a simple on/off control function). 3 mins later the backup electric heater will turn off. The heat pump will then operate until the water temperature rises to the set temperature or the **next command is received**.
- On systems with no auxiliary heat source (AHS), the heat pump will then operate until the water temperature rises to the set temperature or the **next command is received**.

If any error code is displayed during the cool mode running operation, the cause should be investigated. Refer to Part 3, 8.2 "Error Code table".

7.14.7 DHW MODE RUNNING operation

The **DHW MODE RUNNING** operation is used to check the operation of the system in DHW mode.

During the **DHW MODE RUNNING** operation, the DHW set temperature is 55°C. On systems where a tank boost heater is installed, the tank boost heater will turn on once the heat pump has run for 10 mins. The tank boost heater will turn off 3 mins later and the heat pump will operate until the water temperature rises to the set temperature or the **next command is received**.

Figure 3-7.38: HEAT MODE RUNNING display

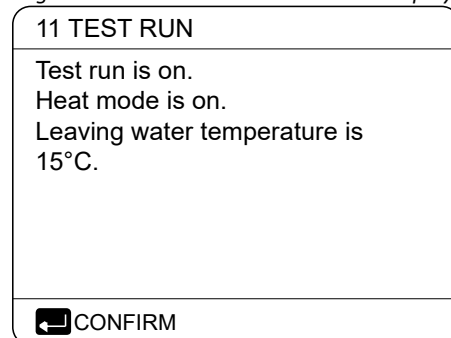
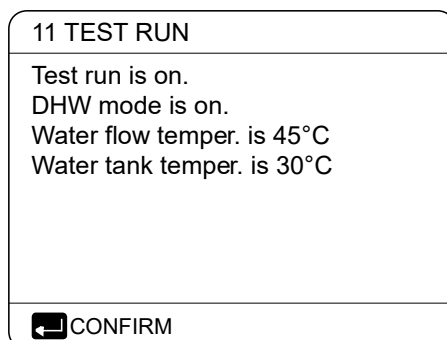

Figure 3-7.39: DHW MODE RUNNING display



Mono

7.15 SPECIAL FUNCTION

7.15.1 SPECIAL FUNCTION menu overview

MENU > FOR SERVICEMAN > SPECIAL FUNCTION

SPECIAL FUNCTION is used to pre-heating floor and drying up floor once installation is complete or the first time start up the unit or restart the unit after a long time stop.

Figure 3-7.40: Special functions menu

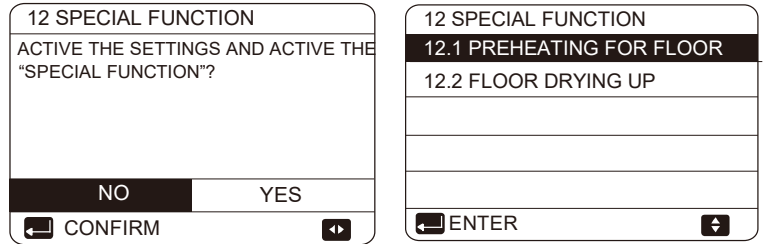

7.15.2 PREHEATING FOR FLOOR

MENU > FOR SERVICEMAN > SPECIAL FUNCTION > PREHEATING FOR FLOOR

Before floor heating, if a large amount of water remains on the floor, the floor may be warped or even rupture during floor heating operation, in order to protect the floor, floor drying is necessary, during which the temperature of the floor should be increased gradually.

During first operation of the unit, air may remain in the water system which can cause malfunctions during operation. It is necessary to run the air purge function to release the air (make sure the air purge valve is open).

T1S sets the heat pump's leaving water set temperature in preheating for floor mode.

t_fristFH sets the duration of preheating for floor mode.

The operation of the unit during preheating for floor mode is illustrated in Figure 3-7.37.

Figure 3-7.41: Preheating for floor menu

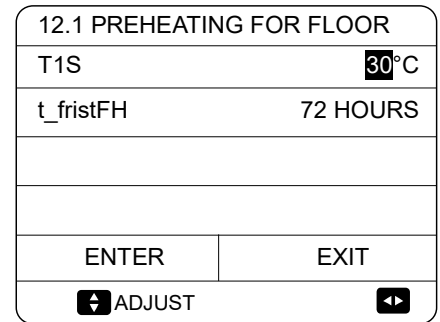
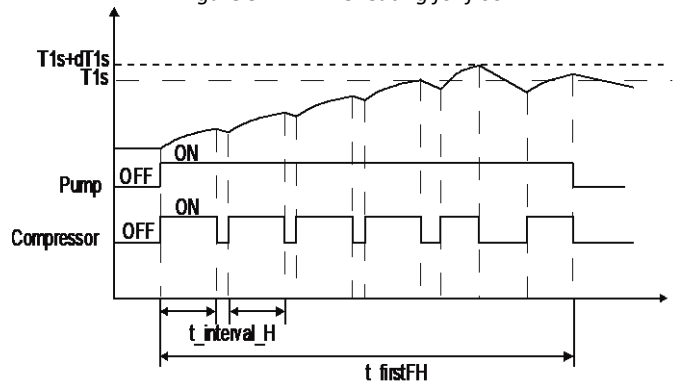

Figure 3-7.42: Preheating for floor



Abbreviations:
 t_interval_H: Compressor re-start delay in space heating mode. (Refer to Part 3, 8.6 "HEAT MODE SETTING Menu").

Whilst the preheating for floor operation is running, the number of minutes that it has been running for and the heat pump's leaving water temperature are displayed on the user interface. During the preheating for floor operation all buttons except **OK** are inactivated. To exit the preheating for floor operation, press **OK** and then select **YES** when prompted. Refer to Figure 3-7.38.

Figure 3-7.43: Preheating for floor screens

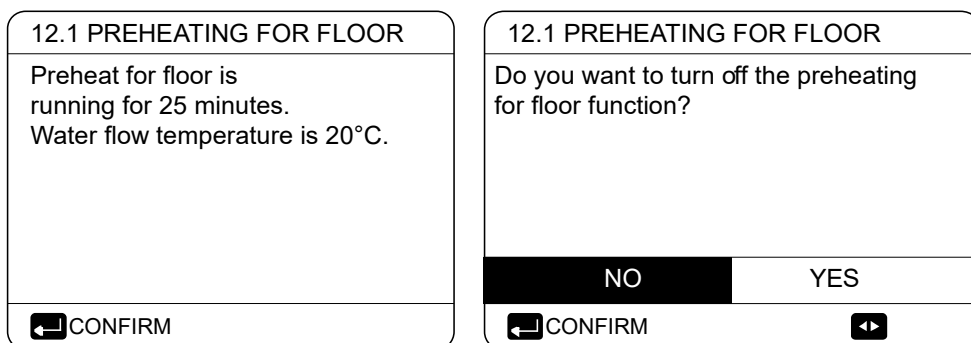

7.15.3 FLOOR DRYING UP

MENU > FOR SERVICEMAN > SPECIAL FUNCTION > FLOOR DRYING UP

Figure 3-7.44: FLOOR DRYING UP menu

12.2 FLOOR DRYING UP	1/2	12.2 FLOOR DRYING UP	2/2
WARM UP TIME(t_DRYUP)	8 days	START DATE	01-01-2019
KEEP TIME(t_HIGHPEAK)	5 days		
TEMP. DOWN TIME(t_DRYDOWN)	5 days		
PEAK TEMP.(T_DRYPEAK)	45°C		
START TIME	15:00	ENTER	EXIT
ADJUST		ADJUST	

For newly-installed under-floor heating systems, floor drying up mode can be used to remove moisture from the floor slab and subfloor to prevent warping or rupture of the floor during floor heating operation. There are three phases to the floor drying up operation:

- Phase 1: gradual temperature increase from a starting point of 25°C to the peak temperature
- Phase 2: maintain peak temperature
- Phase 3: gradual temperature decrease from the peak temperature to 45°C

WARM UP TIME(t_DRYUP) sets the duration of Phase 1.

KEEP TIME(t_HIGHPEAK) sets the duration of Phase 2.

TEMP. DOWN TIME(t_DRYDOWN) is the duration of Phase 3.

PEAK TEMP.(T_DRYPEAK) sets the heat pump’s leaving water set temperature for Phase 2.

START TIME sets the floor drying up operation start time.

START DATE sets the floor drying up operation start date.

Figure 3-7.45: FLOOR DRYING UP settings

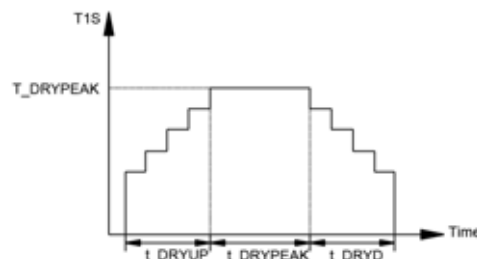

The heat pump’s leaving water set temperature during the floor drying up operation is illustrated in Figure 3-7.40.

During the floor drying up operation all buttons except **OK** are inactivated. To exit the floor drying up operation, press **OK** and then select **YES** when prompted.

Note: In the event of a heat pump malfunction, floor drying up mode will continue if a backup electric heater and/or additional heating source is available and configured to support space heating mode.

Mono

7.16 AUTO RESTART

MENU > FOR SERVICEMAN > AUTO RESTART

AUTO RESTART sets whether or not the unit re-applies the user interface settings when the power returns following a power failure. Select **YES** to enable auto restart or **NON** to disable auto restart.

If the auto restart function is enabled, when the power returns following a power failure, the unit re-applies the user interface settings from before the power failure. If the auto restart function is disabled, when the power returns after a power failure, the unit won't auto restart.

Figure 3-7.47: AUTO RESTART menu

13 AUTO RESTART	
13.1 COOL/HEAT MODE	YES
13.2 DHW MODE	NON
ADJUST	◀▶

7.17 POWER INPUT LIMITATION

MENU > FOR SERVICEMAN > POWER INPUT LIMITATION

POWER INPUT LIMITATION sets the type of power input limitation and the setting range is 0-8. If the unit will operate at larger power input, 0 should be selected. If the unit will operate at a lower power input, 1-8 should be selected and the power input and capacity will decrease.

Figure 3-7.48: POWER INPUT LIMITATION menu

14 POWER INPUT LIMITATION	
14.1 POWER INPUT LIMITATION	0
ADJUST	◀▶

Figure 3-7.49: Limitation value (unit:A)

Model \ No.	0	1	2	3	4	5	6	7	8
4/6kW	18	18	16	15	14	13	12	12	12
8/10kW	19	19	18	16	14	12	12	12	12
12/14kW(1N)	30	30	28	26	24	22	20	18	16
16kW(1N)	30	30	29	27	25	23	21	19	17
12/14kW(3N)	14	14	13	12	11	10	9	9	9
16kW(3N)	14	14	13	12	11	10	9	9	9

7.18 INPUT DEFINE

MENU > FOR SERVICEMAN > INPUT DEFINE

Figure 3-7.50: INPUT DEFINE

15 INPUT DEFINE		15 INPUT DEFINE		15 INPUT DEFINE	
15.1 M1M2	REMOTE	15.6 Ta	HMI	15.11 PUMP_1 SILENT MODE	NON
15.2 SMART GRID	NON	15.7 Ta-adj	-2°C	15.12 DFT1/DFT2	DEFROST
15.3 Tw2	NON	15.8 SOLAR INPUT	NON		
15.4 Tbt1	NON	15.9 F-PIPE LENGTH	<10m		
15.5 Tbt2	NON	15.10 RT/Ta_PCB	NON		
ADJUST	◀▶	ADJUST	◀▶	ADJUST	◀▶

INPUT DEFINE sets sensors and functions to fulfill with installation.

M1M2 sets the control function of M1M2 for remote ON/OFF of unit or AHS or TBH

SMART GRID sets whether SMART GRID control signal is connected to hydronic PCB.

Tw2 sets whether T1b sensor exist in the installation.

Tbt1 set whether balance tank temperature sensors are installed in the balance tank. (Tbt1 sensor, individually purchase;Tbt2, reserved)

Ta sets the Ta sensor connection type (HMI: Ta on wired controller; IDU: Ta connected on hydronic PCB)

Ta-adj is a correction value for Ta.

SOLAR INPUT sets whether solar control signal is connected to hydronic PCB. (0=NON; 1=CN18; Tsolar 2=CN11SL1SL2)

F-PIPE LENGTH sets the length of refrigerant pipes between outdoor unit and indoor unit.

RT/Ta_PCB sets whether M-kit is valid.

Pump silent mode can decrease water pump maximum output by 5% in order to decrease the noise of heat pump.

DFT1/DFT2 sets DFT1 and DFT2 port of the hydro module as DEFROST or Alarm(ALARM function can be valid only with IDU software version higher than V99)

7.19 CASCADE SET

MENU > FOR SERVICEMAN > CASCADE SET

Figure 3-7.51: CASCADE SET

16 CASCADE SET	
16.1 PER_START	20%
16.2 TIME_ADJUST	5 MIN
16.3 ADDRESS RESET	FF
 ADJUST	

PER_START sets the start-up percentage of multiple units for the first time start-up after power on. For example:

Total units	PER_START	Starting units
6	50%	3
6	30%	2



TIME_ADJUST sets the judgment period of adding and subtracting units

ADDRESS RESET resets the address code of unit.("FF" is an invalid address code.) Normally, program will set the address for each unit automatically, only when unit lost address and Hd error code appears then we need to use this function. After setting the address, you need to press the "UNLOCK" key to confirm.

7.20 HMI ADDRESS SET

MENU > FOR SERVICEMAN > HMI ADDRESS SET

Figure 3-7.52: HMI ADDRESS SET

17 HMI ADDRESS SET	
17.1 HMI SET	MASTER
17.2 HMI ADDRESS FOR BMS	1
17.3 STOP BIT	1
 	

HMI SET sets the wired controller is master or slave. (0=MASTER, 1=SLAVE)

When HMI SET is set to SLAVE, the controller can only switch the operation mode, turn on or off, set the temperature, and cannot set other parameters and functions.

HMI ADDRESS FOR BMS sets the HMI address code for BMS.(only valid for master controller)

Mono

The **STOP BIT** of wired controller and upper computer software should be the same to ensure the reliability of data transformation.

8 Operation parameter

MENU > OPERATION PARAMETER

This menu is for installer or service engineer reviewing the operation parameters. There are nine pages for the operating parameter as following

Figure 3-9.1: Operation parameter

OPERATION PARAMETER #01	OPERATION PARAMETER #01	OPERATION PARAMETER #01
ONLINE UNITS NUMBER 1	PUMP-O OFF	GAS BOILER OFF
OPERATE MODE COOL	PUMP-C OFF	T1 LEAVING WATER TEMP. 35°C
SV1 STATE ON	PUMP-S OFF	WATER FLOW 1.72m ³ /h
SV2 STATE OFF	PUMP-D OFF	HEAT PUMP CAPACTIY 11.52kW
SV3 STATE OFF	PIPE BACKUP HEATER OFF	POWER CONSUM. 1000kWh
PUMP_I ON	TANK BACKUP HEATER ON	Ta ROOM TEMP 25°C
ADDRESS 1/9	ADDRESS 2/9	ADDRESS 3/9

OPERATION PARAMETER #01	OPERATION PARAMETER #01	OPERATION PARAMETER #01
T5 WATER TANK TEMP. 53°C	Tbt1 BUFFERTANK_UP TEMP. 35°C	ODU MODEL 6kW
Tw2 CIRCUIT2 WATER TEMP. 35°C	Tbt2 BUFFERTANK_LOW TEMP. 35°C	COMP.CURRENT 12A
TIS' C1 CLIMATE CURVE TEMP. 35°C	Tsolar 25°C	COMP.FREQUENCY 24Hz
TIS2' C2 CLIMATE CURVE TEMP. 35°C	IDU SOFTWARE 01-09-2019V01	COMP.RUN TIME 54 MIN
TW_O PLATE W-OUTLET TEMP. 35°C		COMP.TOTAL RUN TIME 1000Hrs
TW_I PLATE W-OUTLET TEMP. 30°C		EXPANSION VALVE 200P
ADDRESS 4/9	ADDRESS 5/9	ADDRESS 6/9

OPERATION PARAMETER #01	OPERATION PARAMETER #01	OPERATION PARAMETER #01
FAN SPEED 600R/MIN	TW_O PLATE W-OUTLET TEMP. 35°C	T3 OUTDOOR EXCHANGE TEMP. 5°C
IDU TARGET FREQUENCY 46Hz	TW_I PLATE W-INLET TEMP. 30°C	T4 OUTDOOR AIR TEMP. 5°C
FREQUENCY LIMITED TYPE 5	T2 PLATE F-OUT TEMP. 35°C	TF MODULE TEMP. 55°C
SUPPLY VOLTAGE 230V	T2B PLATE F-IN TEMP. 35°C	P1 COMP. PRESSURE 2300kPa
DC GENERATRIX VOLTAGE 420V	Th COMP. SUCTION TEMP. 5°C	ODU SOFTWARE 01-09-2018V01
DC GENERATRIX CURRENT 18A	Tp COMP. DISCHARGE TEMP. 75°C	HMI SOFTWARE 01-09-2018V01
ADDRESS 7/9	ADDRESS 8/9	ADDRESS 9/9

9 Network Configuration Guidelines

The wired controller realizes intelligent control with a built-in WIFI module, which receives control signal from the APP. Before connecting the WLAN, please check for it if the router in your environment is active and make sure that the wired controller is well-connected to the wireless signal. When the product is connected to the network, please make sure that the phone is as close as possible to the product. KAISAI only supports 2.4GHz band routers at present. Special characters (punctuation, spaces, etc.) are not recommended as part of the WLAN name. It is recommended that you connect no more than 10 devices to a single router lest home appliances are affected by weak or unstable network signal. If the password of the router or WLAN is changed, clear all settings and reset the appliance. APP interface changes from time to time as APP is updated and may change slightly vary from those in this document.

9.1 Install APP

Scan the following QR code or research "Comfort Home" in APP STORE or GOOGLE PLAY to install the APP.



9.2 First run

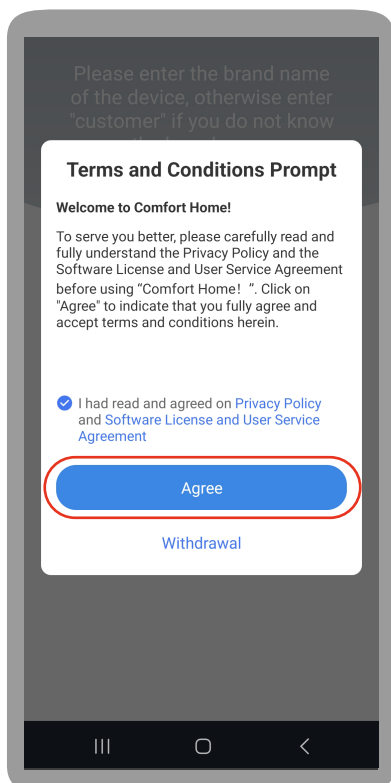

After installation, open the APP and read and accept the privacy policy.

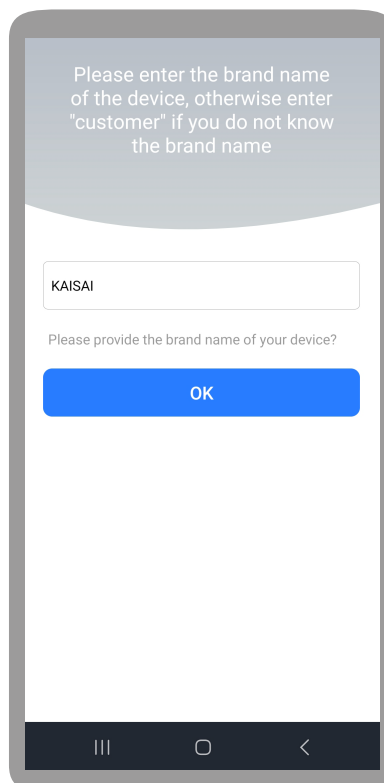

Enter the registration code - „KAISAI”

9.3 Log in or register

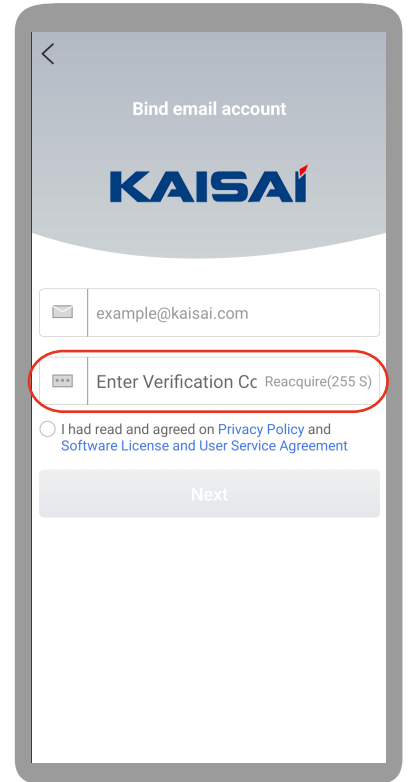
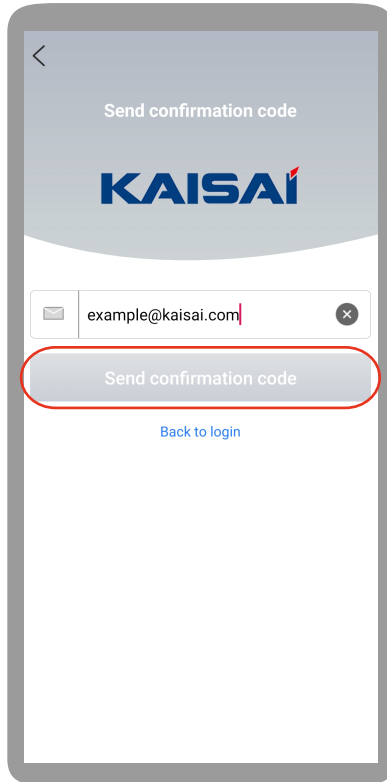
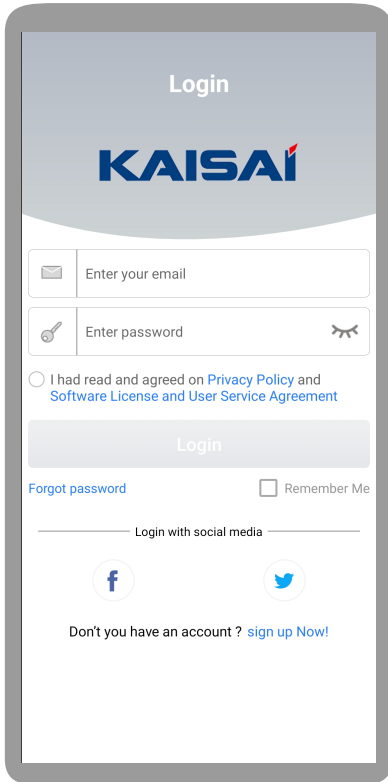

In case of a new user registration it is necessary to enter a verification code sent to the specified e-mail address.

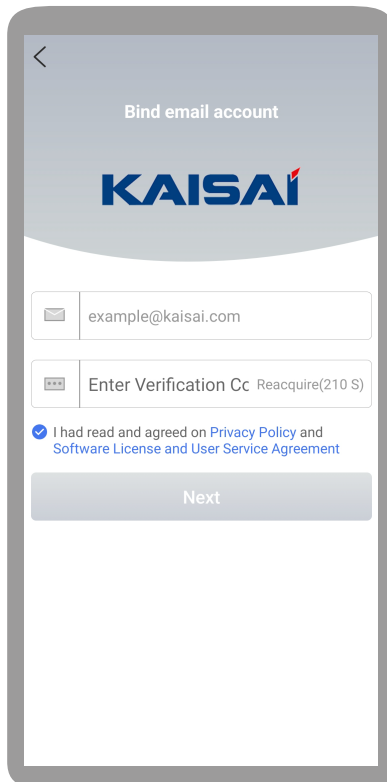

Accept the privacy policy and conditions for using the application

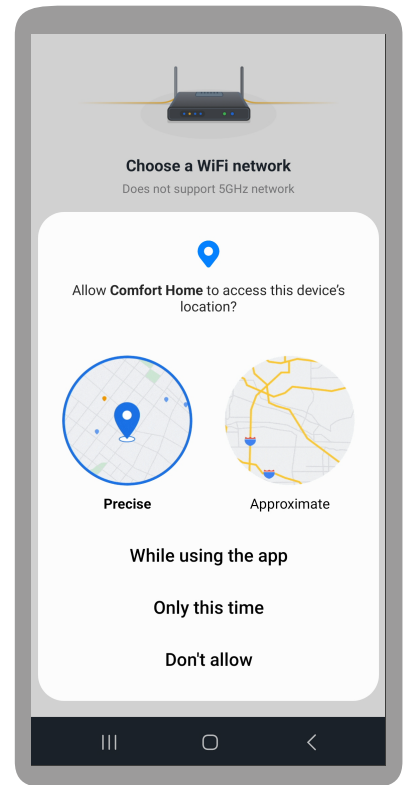
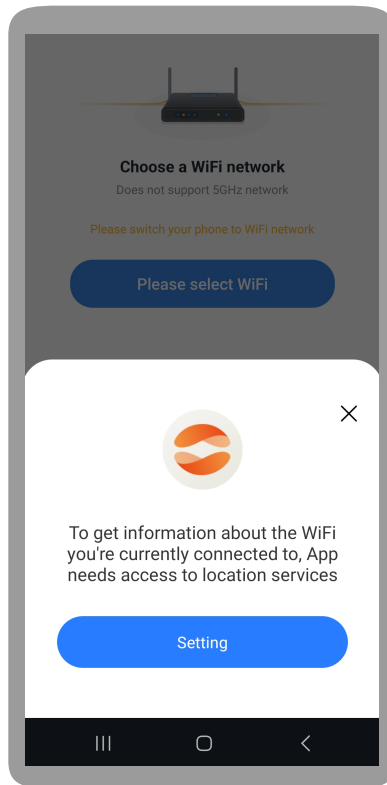
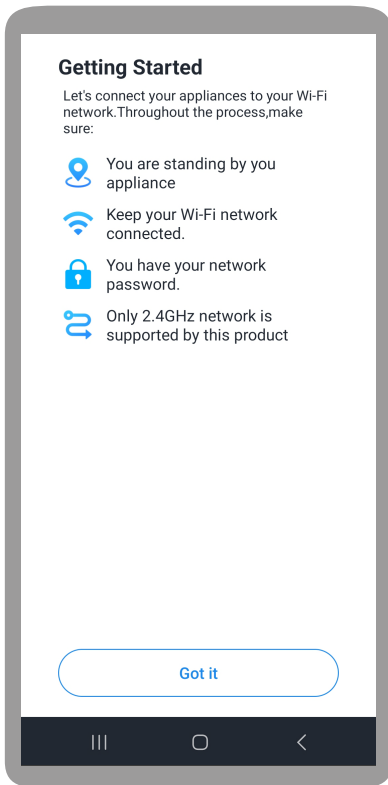

9.4 Wi-Fi connection

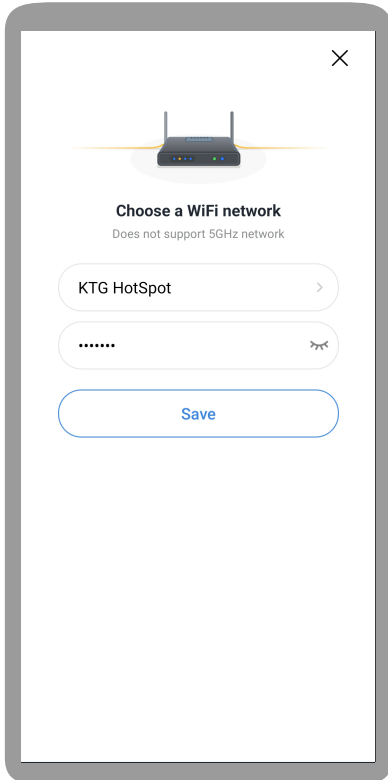

Network name and password may not contain languagespecific or special characters.

9.5 Device management



From the application, you can add new devices or manage existing ones.

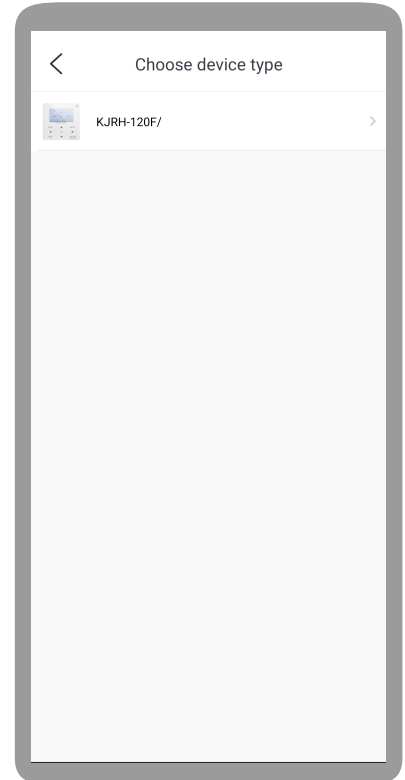

9.6 AP mode on the controller

Choose the right arrow on the controller to go to the AP mode.

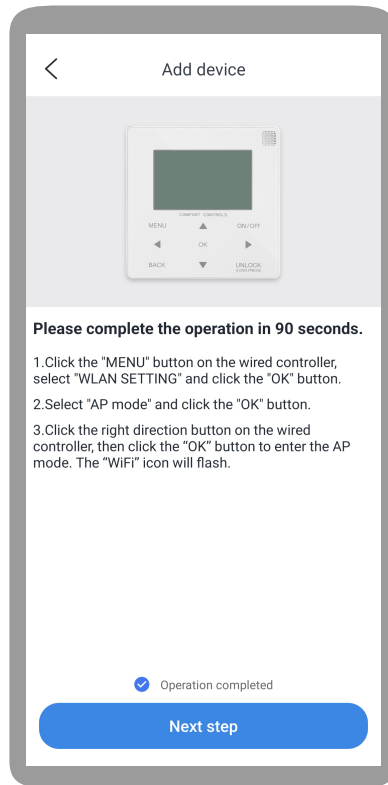

When the Wi-Fi icon starts to flash, move forward.

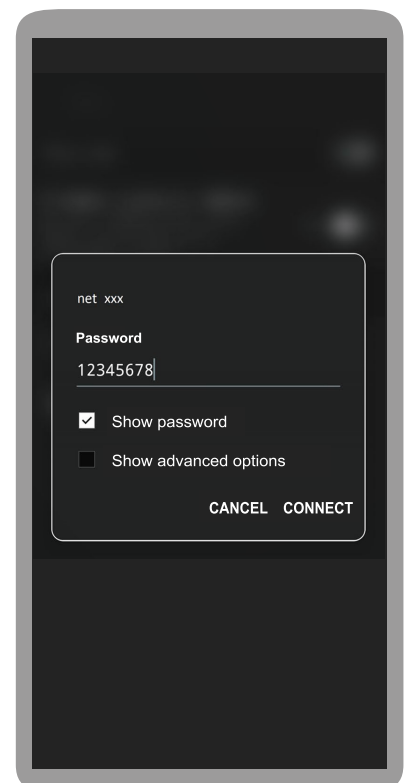
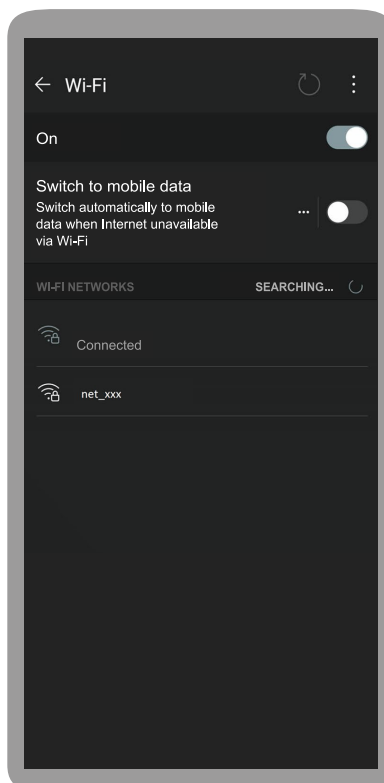
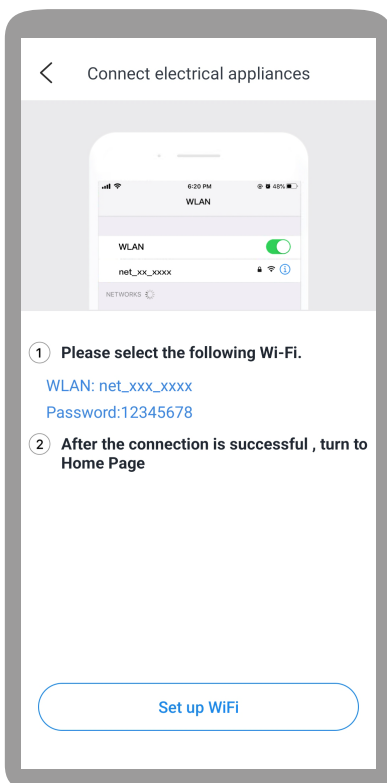

No access to the Internet

Confirm the message displayed on the phone's screen by choosing OK.

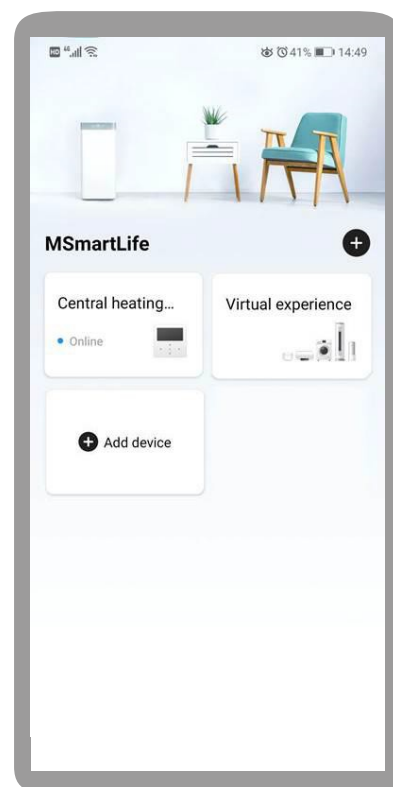
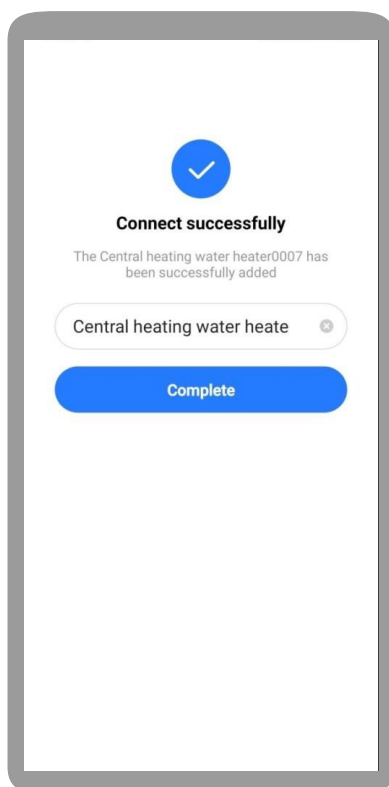
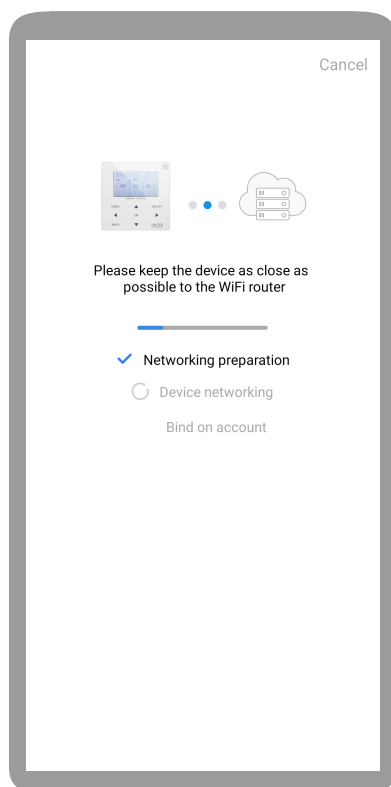
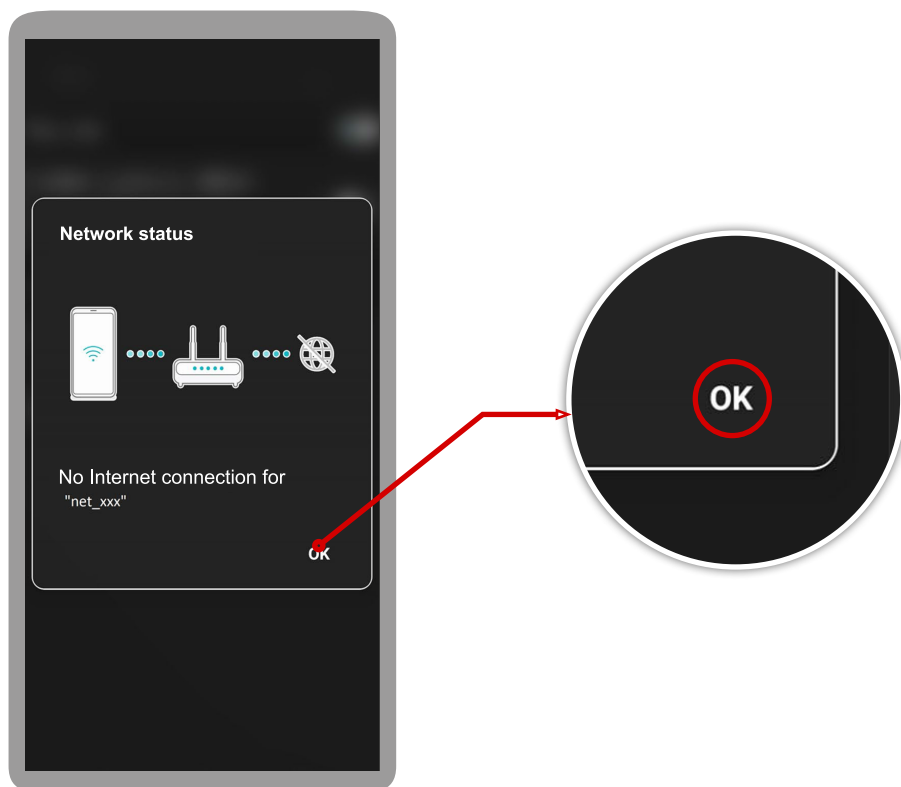

10 USB function guidelines

10.1 Parameters setting transfer between wired controllers

Installer can quickly copy the wired controller parameter settings from unit A to unit B via USB disk, which save the time of on-site installation. Steps are as follows:

Step 1:

Plug U disk into the port of hydronic PCB of A unit.

“USB” appears on digital display

Wired controller interface automatically changes

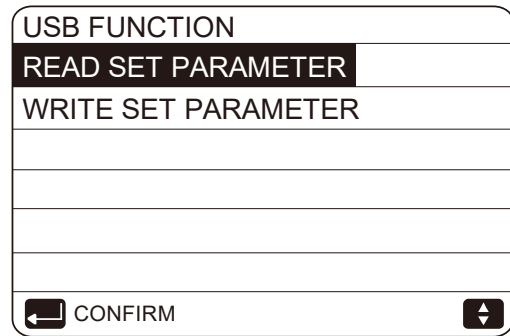
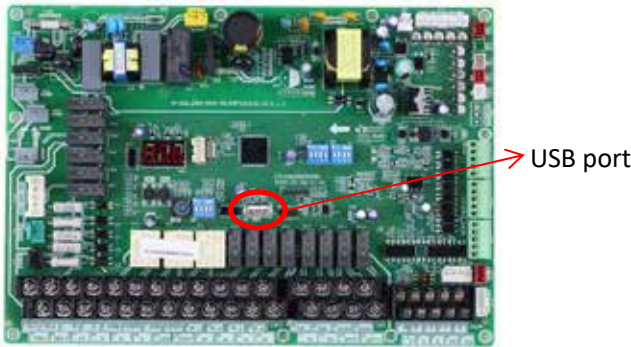

Step 2:

Select “READ SET PARAMETER” and press “OK” button then rate of progress will appear. When the process is finished, “SUCCESS” appears below and an EXCEL file which can not be seen in the wired controller interface but users can find it on computer will be generated inside the USB disk.

Select “READ SET PARAMETER”

Finished

EXCEL generated

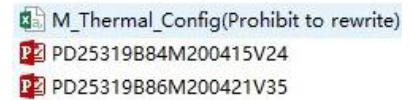
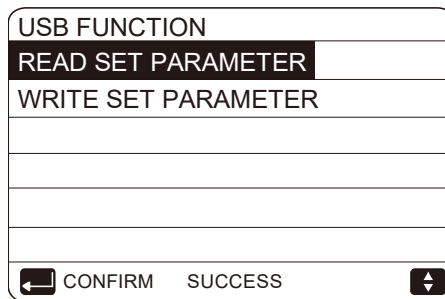
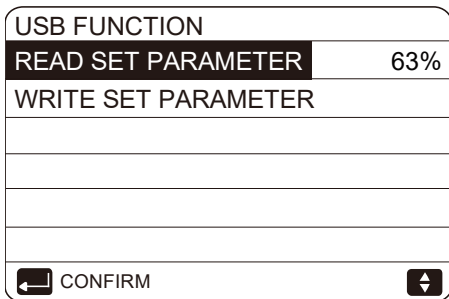

After that, if parameter correction is needed, please connect the USB with computer and open the EXCEL file to change parameters and then save it. Please do not change the file name or format. Parameters are not allowed for non-professionals to change and Midea recommends to use the wired controller to change the parameters.

Step 3:

Plug USB disk into the port of hydronic PCB of B unit and select “WRITE SET PARAMETER” then rate of progress will appear. When the process is finished, “SUCCESS” appears below.

Select “WRITE SET PARAMETER”

Finished

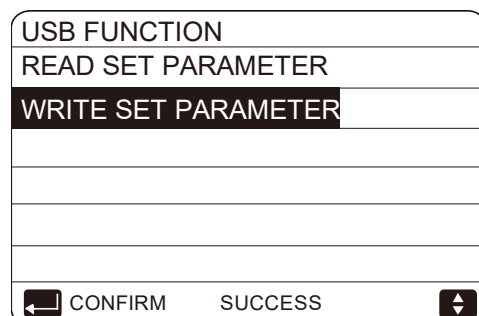
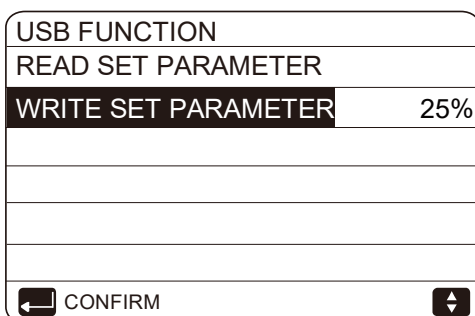

10.2 Convenient program upgrade for unit

There is no need to carry any heavy equipment but only USB disk can realize program upgrade. Steps are as follows:

Step 1:

Copy new program in U disk root directory where other files in bin format are not allowed in

Step 2:

Power on and make sure communication is normal.

Step 3:

Plug U disk into the port of hydronic PCB.

“USB” appears on digital display

Wired controller interface automatically changes

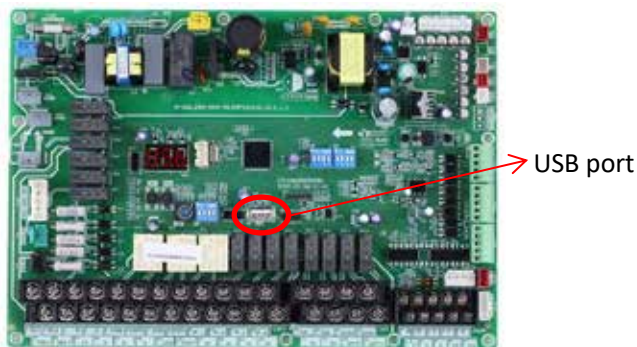

USB FUNCTION
RATED SET PARAMETER
WRITE SET PARAMETER
PD25319B84M200415V24.bin
PD25319B86M200415V24.bin
CONFIRM

Step 4:

Please distinguish between programs for main control PCB and hydronic PCB. Select one of them and press “OK” button then rate of progress appears. When the process is finished, “SUCCESS” appears below. For upgrading outdoor unit, the process normally lasts for several minutes while only few seconds is needed for indoor unit.

Select program

USB FUNCTION
RATED SET PARAMETER
WRITE SET PARAMETER
PD25319B84M200415V24.bin 51%
PD25319B86M200415V24.bin
CONFIRM

Finished

USB FUNCTION
RATED SET PARAMETER
WRITE SET PARAMETER
PD25319B84M200415V24.bin
PD25319B86M200415V24.bin
CONFIRM

Step 5:

Pull out U disk and power on again to finish upgrading program. Check the program version to make sure upgrade is successful.

Check IDU software version

OPERATION PARAMETER	#00
Tbt1 BUFFERTANK_UP TEMP.	XX °C
Tbt2 BUFFERTANK_LOW TEMP.	XX °C
Tsolar	XX °C
IDU SOFTWARE	XX-XX-XXXXXXX
ADDRESS	5/9

Check ODU software version

OPERATION PARAMETER	#00
T3 OUTDOOR EXCHANGE TEMP.	XX °C
T4 OUTDOOR AIR TEMP	XX °C
TF MODULE TEMP.	XX °C
P1 COMP PRESSURE	XX Kpa
ODU SOFTWARE	XX-XX-XXXXXXX
HMI SOFTWARE	XX-XX-XXXXXXX
ADDRESS	9/9

11 Climate Related Curves

The climate related curves can be selected in the user interface, **MENU > PRESET TEMPERATURE > WEATHER TEMP. SET.**

In cooling/mode mode, eight curves which are already set in the user interface can be selected. Once the curve is selected, the leaving water set temperature (T1s) is determined by the outdoor temperature (T4).

ECO mode is only suitable for heating mode. It has lower water temperature setting inside the program, which is more energy saving.

The relationship between outdoor ambient temperature (T4) and leaving water set temperature (T1s) is described as in Figure 3-9.2, Figure 3-9.3, Figure 3-9.4 and Figure 3-9.5.

Figure 3-9.1: WEATHER TEMP. SET menu

PRE SET TEMPERATURE		
PRESET TEMP	WEATHER TEMPSET	ECO MODE
ZONE1 C-MODE LOW TEMP	OFF	OFF
ZONE1 H-MODE LOW TEMP	OFF	OFF
ZONE2 C-MODE LOW TEMP	OFF	OFF
ZONE2 H-MODE LOW TEMP	OFF	OFF
ON/OFF		↕

Figure 3-9.2: Low temperature curves for heating mode¹

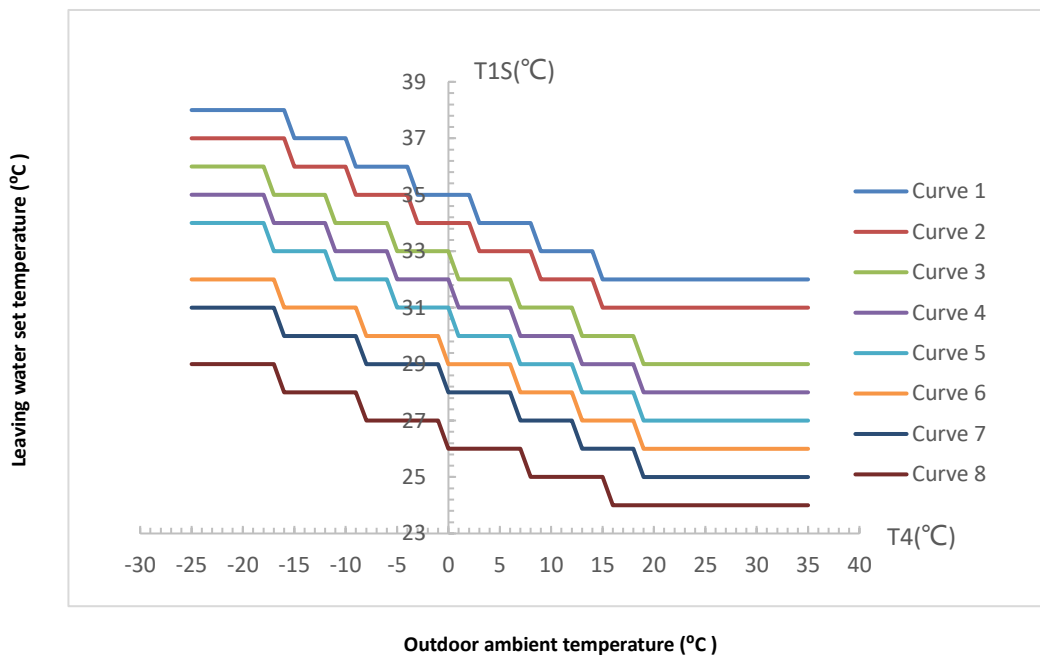

Notes:

1. It only has the curves of the low temperature setting for heating, if the low temperature is set for heating.
2. Curve 4 is default in low temperature heating mode and curve 6 is default in ECO mode.

Figure 3-9.3: High temperature curves for heating mode¹

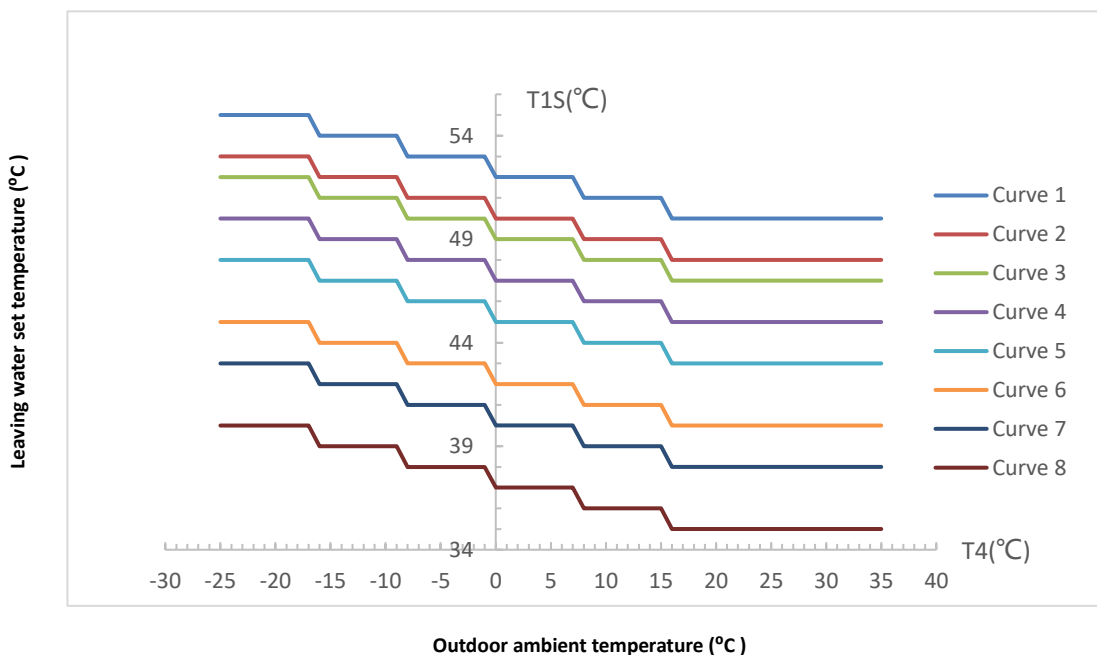

Notes:

1. It only has the curves of the high temperature setting for heating, if the high temperature is set for heating.
2. Curve 4 is default in high temperature heating mode and curve 6 is default in ECO mode.

Figure 3-9.4: Low temperature curves for cooling mode¹

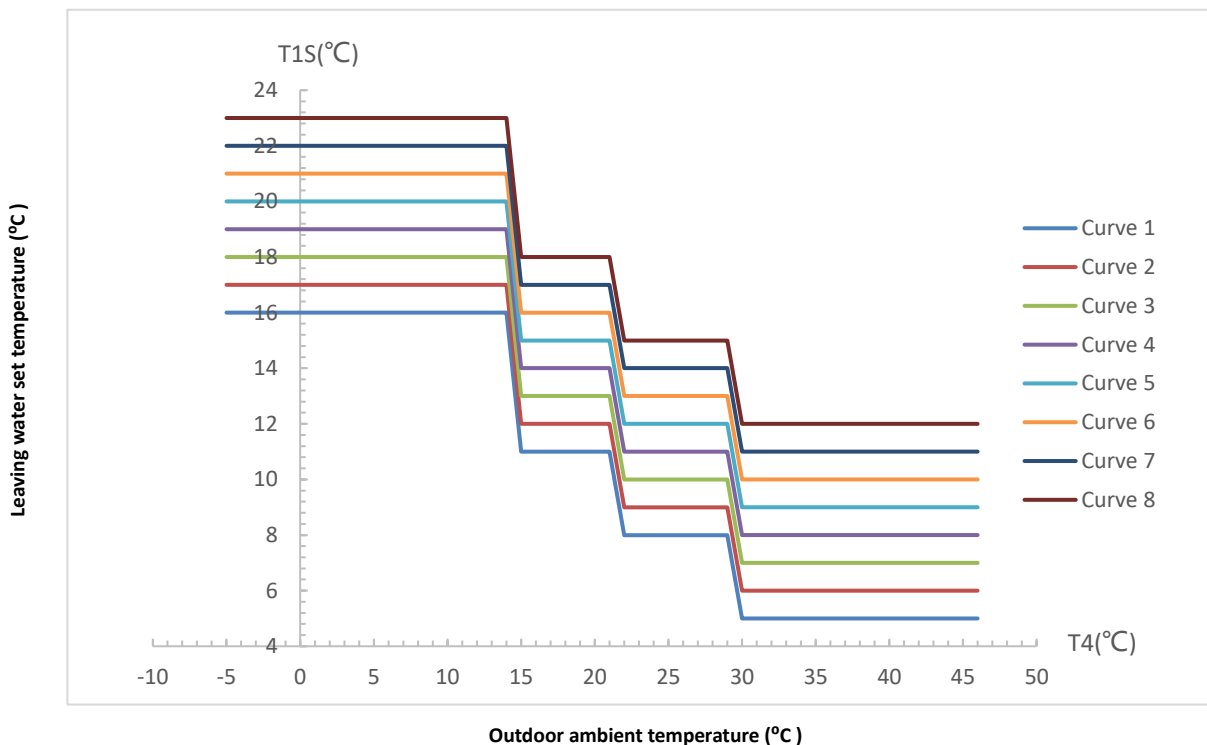

Notes:

1. It only has the curves of the low temperature setting for cooling, if the low temperature is set for cooling.
2. Curve 4 is default in low temperature cooling mode and curve 6 is default in ECO mode.

Figure 3-9.5: High temperature curves for cooling mode¹

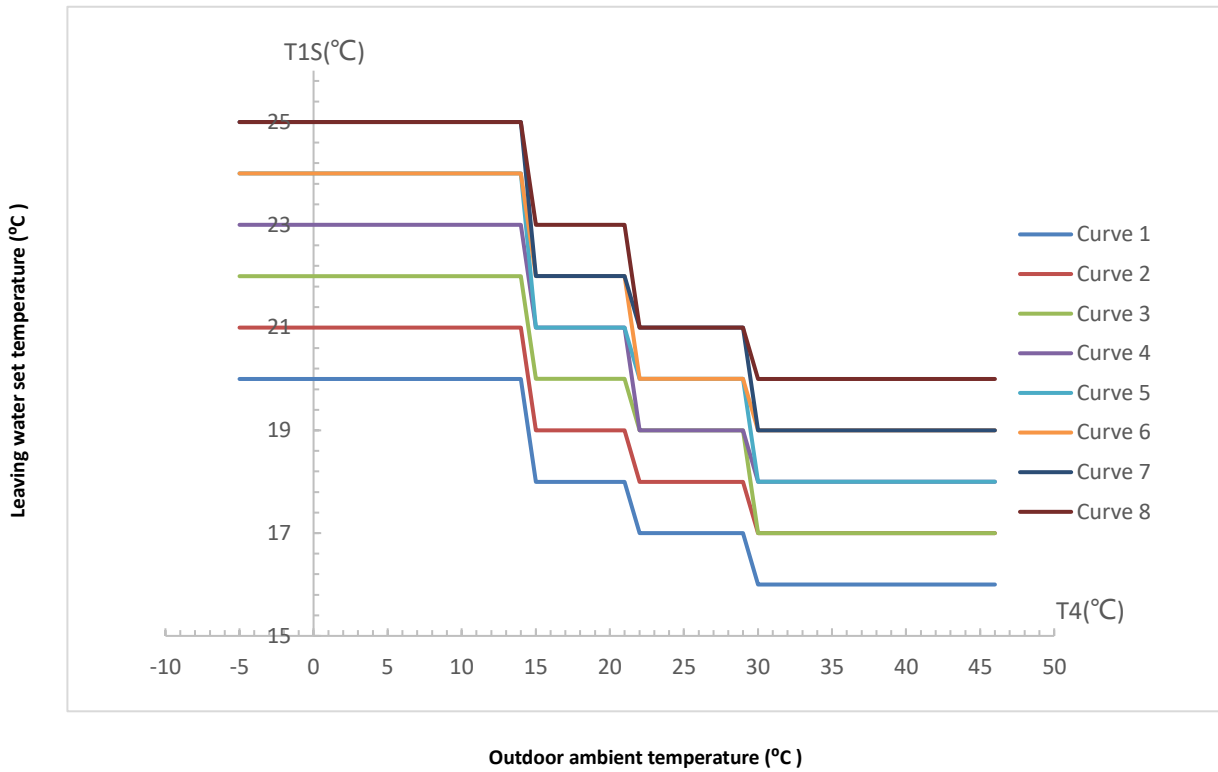

Notes:

1. It only has the curves of the high temperature setting for cooling, if the high temperature is set for cooling.
2. Curve 4 is default in high temperature cooling mode and curve 6 is default in ECO mode.

There is one customized curve which can set by user according to using habits. Users just need to input the ambient temperature and desire water temperature for two working condition to build the customized curve. The setting of T1SETH1, T1SETH2, T4H1, T4H2 refer to Part 3, 8.6" HEATING MODE SETTING Menu" and T1SETC1, T1SETC2, T4C1, T4C2 refer to Part 3, 8.5" COOLING MODE SETTING Menu".

Figure 3-9.6: Automatic setting curve for heating mode

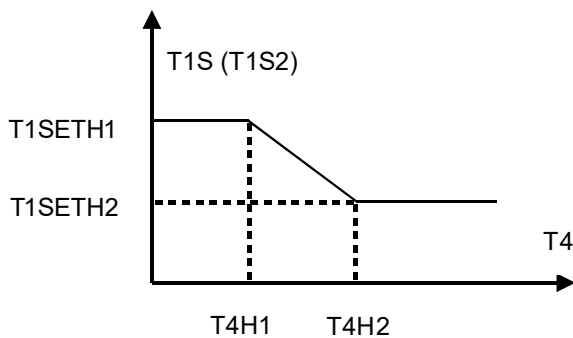
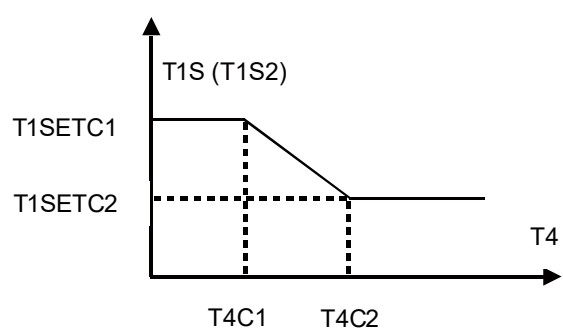

Figure 3-9.7: Automatic setting curve for cooling mode



12 Error Code Table

Table 3-10.1: Error code table

Error code	Content ²
C7	Transducer module temperature too high protect
E0	Water flow failure (E8 appears 3 times)
E1	Phase sequence error (for 3 phase models)
E2	Communication error between the main control board of hydraulic module and user interface
E3	Backup electric heater exchanger water outlet temperature sensor T1 error
E4	Domestic hot water tank temperature sensor T5 error
E5	Air side heat exchanger refrigerant outlet temperature sensor T3 error
E6	Outdoor ambient temperature sensor T4 error
E7	Balance tank sensor Tbt1 error
E8	Water flow failure within 3 times
E9	Suction pipe temperature sensor Th error
EA	Discharge pipe temperature sensor Tp error
Eb	Solar board sensor Tsolar error
Ec	Balance tank sensor Tbt2 error
Ed	Water side heat exchanger water inlet temperature sensor Twin error
EE.	Hydronic box EEPROM error
F1	DC generatrix voltage is too low
H0	Communication error between outdoor unit main control chip and hydronic box main control chip
H1	Communication error between outdoor unit main control chip and inverter driver chip
H2	Water side heat exchanger refrigerant outlet (liquid pipe) temperature sensor error
H3	Water side heat exchanger refrigerant inlet (gas pipe) temperature sensor error
H4	Inverter module protection (L0/L1 appear 3 times in one hour)
H5	Room temperature sensor Ta error
H6	DC fan error
H7	Abnormal main circuit voltage
H8	Pressure sensor error
H9	Zone 2 water outlet temperature sensor Tw2 error
HA	Water side heat exchanger water outlet temperature sensor error
Hb	PP protection three times in a row and Twout<7°C
Hd	Communication fault between master unit and slave unit (in parallel)
HE	Communication error between main board and thermostat transfer board
H.F.	Refrigerant system EEPROM error
HH	H6 appears 10 times in 120min
HP	Low pressure protection (pressure < 0.6MPa for 3 times in one hour)
P0	Low pressure protection
P1	High pressure protection
P3	Compressor current protection
P4	Discharge temperature sensor Tp protection
P5	High temperature difference between water side heat exchanger water inlet and water outlet temperatures protection
P6	Inverter module protection
L0	Inverter module protection
L1	DC bus low voltage protection

Mono

L2	DC bus high voltage protection
L4	MCE error
L5	Zero speed protection
L7	Phase sequence error
L8	Compressor frequency variation greater than 15Hz within one second protection
L9	Actual compressor frequency differs from target frequency by more than 15Hz protection
Pb	Water side heat exchanger anti-freeze protection
Pd	High temperature protection of refrigerant outlet temperature of condenser in cooling mode
PP	Water side heat exchanger inlet temperature is higher than outlet temperature in heating/DHW mode
bH	PED board error



**WE
CARE
ABOUT
AIR**

kaisai.com